

XStream™ OEM RF Module

900 MHz & 2.4 GHz OEM RF Modules

Module Operation

Module Configuration

Appendices



Product Manual [v4.2B](#)

For XStream OEM RF Module Part Numbers:

X09-001...	X24-009...	XH9-001...
X09-009...	X24-019...	XH9-009...
X09-019...		XH9-019...



355 South 520 West, Suite 180

Lindon, UT 84042

Phone: (801) 765-9885

Fax: (801) 765-9895

rf-xperts@maxstream.net

www.maxstream.net

M100018
2005.10.27

© 2005 MaxStream, Inc. All rights reserved

No part of the contents of this manual may be transmitted or reproduced in any form or by any means without the written permission of MaxStream, Inc.

XStream™ is a registered trademark of MaxStream, Inc.

Technical Support

Phone: (801) 765-9885

Live Chat: www.maxstream.net

E-Mail: rf-xperts@maxstream.net

Contents

1. XStream™ OEM RF Module	4	Appendix A: Agency Certifications	31
1.1. Features	4	FCC Certification	31
1.1.1. Worldwide Acceptance	4	OEM Labeling Requirements	32
1.2. Specifications	5	Antenna Usage	32
1.3. Pin Signals	6	FCC-Approved Antennas	33
1.4. Electrical Characteristics	7	European Compliance (2.4 GHz only)	34
1.4.1. Timing Specifications	7	OEM Labeling Requirements	34
1.5. Mechanical Drawings	8	Restrictions	34
2. Module Operation	9	Europe (2.4 GHz) Approved Antenna List	35
2.1. Serial Communications	9	IC (Industry Canada) Certification	35
2.1.1. UART-Interfaced Data Flow	9	Appendix B: Development Guide	36
2.1.2. Flow Control	10	XStream OEM Development Kit Contents	36
2.2. Modes of Operation	11	Interfacing Hardware	36
2.2.1. Idle Mode	11	MaxStream RS-232/485 Interface Board	37
2.2.2. Transmit Mode	11	Adapters	39
2.2.3. Receive Mode	13	Antennas	40
2.2.4. Sleep Mode	13	Interfacing Protocols	41
2.2.5. Command Mode	14	RS-232 Operation	41
3. Module Configuration	16	RS-485 (2-wire) Operation	43
3.1. Hands-on Programming Examples	16	RS-485 (4-wire) & RS-422 Operation	44
3.1.1. AT Command Example	16	X-CTU Software	46
3.1.2. Binary Command Example	16	Using the X-CTU Software	46
3.2. Command Reference	17	Appendix C: Additional Information	47
3.3. Command Descriptions	18	1-Year Warranty	47
		Ordering Information	47
		Contact MaxStream	48

1. XStream™ OEM RF Module

The XStream OEM RF Module is a drop-in wireless solution that transfers a standard asynchronous serial data stream over-the-air between devices. The module stands out in the RFd2d (radio frequency device-to-device) segment of the wireless market with its unique combination of high-performance, ease-of-use and low price.



1.1. Features

Long Range

9XStream (900 MHz) Range:

- Indoor/Urban: **up to 1500'** (450 m)
- Outdoor line-of-sight: **up to 7 miles** (11 km) w/ 2.1 dBm dipole antenna
- Outdoor line-of-sight: **up to 20 miles** (32 km) w/ high gain antenna

24XStream (2.4 GHz) Range:

- Indoor/Urban: **up to 600'** (180 m)
- Outdoor line-of-sight: **up to 3 miles** (5 km) w/ 2.1 dBm dipole antenna
- Outdoor line-of-sight: **up to 10 miles** (16 km) w/ high gain antenna

Receiver Sensitivity: **-110 dBm** (900 MHz),
-105 dBm (2.4 GHz)

Advanced Networking & Security

True peer-to-peer (no "master" required), point-to-point, point-to-multipoint, multidrop

Retries and Acknowledgements

7 hopping channels, each with over 65,000 available network addresses

FHSS (Frequency Hopping Spread Spectrum)

Easy-to-Use

5 VDC (± 0.25 V) power supply

Continuous RF data stream up to 19.2 kbps

No configuration required

Advanced configurations available through standard AT Commands

Portable (small form factor easily designed into a wide range of data radio systems)

Software-selectable serial interfacing rates

MODBUS, CTS, RTS, DTR, DCD (& more) I/O Support

Support for multiple data formats (parity, start and stop bits, etc.)

XII™ Interference Immunity

Power-saving Sleep Modes

Free & Unlimited

World Class Technical Support

1.1.1. Worldwide Acceptance

FCC Certified (USA) - Go to Appendix A for FCC Requirements.

Systems that include XStream Modules inherit MaxStream's FCC Certification

ISM (Industrial, Scientific & Medical) frequency band

Manufactured under **ISO 9001:2000 registered standards**

9XStream (900 MHz) OEM RF Modules are approved for use in **US, Canada, Australia, Israel** (and more). 24XStream (2.4 GHz) Modules add **Europe (EU)** and other approvals.



1.2. Specifications

Table 1.1. XStream OEM RF Module Specifications

Specification	9XStream (900 MHz) OEM RF Module	24XStream (2.4 GHz) OEM RF Module
Performance		
Indoor/Urban Range	up to 1500' (450 m)	up to 600' (180 m)
Outdoor line-of-sight Range	Up to 7 miles (11 km) w/ dipole antenna Up to 20 miles (32 km) w/ high-gain antenna	Up to 3 miles (5 km) w/ dipole antenna Up to 10 miles (16 km) w/ high-gain antenna
Interface Data Rate	125 – 65,000 bps (Software selectable, includes non-standard baud rates)	125 – 65,000 bps (Software selectable, includes non-standard baud rates)
Throughput Data Rate	9,600 bps	19,200 bps
RF Data Rate	10,000 bps	20,000 bps
Transmit Power Output	100 mW (20 dBm)	50 mW (17 dBm)
Receiver Sensitivity	-110 dBm	-102 dBm
Power Requirements		
Supply Voltage	5 VDC (\pm 0.25 V) regulated	5 VDC (\pm 0.25 V) regulated
Receive Current	50 mA	80 mA
Transmit Current	140 mA	150 mA
Power Down Current	< 26 μ A	< 26 μ A
General		
Frequency Range	902-928 MHz	2.4000-2.4835 GHz
Spread Spectrum	Frequency Hopping, Wide band FM modulator	
Network Topology	Peer-to-Peer, Point-to-Multipoint, Point-to-Point, Multidrop	
Channel Capacity	7 hop sequences share 25 frequencies	
Serial Data Interface	CMOS UART	
Physical Properties		
Module Board Size	1.600" x 2.825" x 0.350" (4.06 cm x 7.18 cm x 0.89 cm)	
Weight	0.8 oz (24 g)	
Connector	11-pin & 4-pin, 0.1" spaced male Berg-type headers	
Operating Temperature	0 to 70° C (commercial), -40 to 85° C (industrial)	
Antenna		
Integrated Wire (optional)	¼ wave monopole, 3" (7.62 cm) length, 1.9 dBi Gain	
Connector (optional)	Reverse-polarity SMA or MMCX	
Impedance	50 ohms unbalanced	
Certifications (visit www.maxstream.net for complete list)		
FCC Part 15.247	OUR9XSTREAM	OUR-24XSTREAM
Industry Canada (IC)	4214A-9XSTREAM	4214A 12008
Europe	N/A	ETSI, CE

1.3. Pin Signals

Figure 1.1. XStream OEM RF Module Pin Numbers (bottom view, pins protruding)



Table 1.2. J1 Pin Signal Descriptions

(Low-asserted signals distinguished with a horizontal line over signal name.)

Module Pin	Signal Name	I/O	When Active	Function
1	DO2 / <u>CTS</u> / RS-485 Enable	O*	low	CTS (clear-to-send) flow control – When pin is driven low, UART host is permitted to send serial data to the module. Refer to the Serial Communications [p9] and CS Command [p19] sections for more information. RS-485 Enable – To configure this pin to enable RS-485 (2-wire or 4-wire) communications, refer to the Serial Communications [p9] and CS Command [p19] sections.
2	DI3 / SLEEP	I*	high	By default, DI3 pin is not used. To configure this pin to support Sleep Modes, refer to the Sleep Mode [p13], SM Command [p27] and PW Command [p24] sections.
3	DO (data out)	O*	n/a	Serial data exiting the module (to the UART host). Refer to the Serial Communications [p9] section for more information.
4	DI (data in)	I	n/a	Serial data entering the module (from UART host). Refer to the Serial Communications [p9] section for more information.
5	DI2 / <u>RTS</u> / CMD	I**	low	RTS (request-to-send) flow control – By default, this pin is not used. To configure this pin to regulate the flow of serial data exiting the module, refer to the Serial Communications [p9] and RT Command [p26] sections. CMD –Refer to Binary Commands [p15] and RT Command [p26] sections to enable binary command programming.
6	<u>RESET</u>	I*	low	Re-boot module.
7	DO3 / RX LED	O	high	Pin is driven high during RF data reception; otherwise, the pin is driven low. Refer to the CD Command [p19] to enable.
8	<u>TX</u> / PWR	O	low	TX - Pin pulses low during RF transmission.
			high	PWR – Indicates power is on and module is not in Sleep Mode.
9	<u>CONFIG</u>	I***	low	Pin can be used as a backup method for entering Command Mode during power-up. Primary method is with “+++”. Refer to the Command Mode [p14] section for more information.
10	VCC	I	-	5 VDC regulated (± 0.25)
11	GND	-	-	Ground

* Module has 10K Ω internal pull-up resistor

** Module has 10K Ω internal pull-down resistor

*** Module has 100K Ω internal pull-up resistor

Note: When integrating the XStream Module with a Host PC Board, all lines that are not used should be left disconnected (floating).

Table 1.3. J2 Pin Signal Descriptions

Module Pin	Signal Name
1	reserved
2	GND
3	GND
4	GND

J2 Pins are used primarily for mechanical stability and may be left disconnected.

1.4. Electrical Characteristics

Figure 1.2. System Block Diagram
Basic wireless link between hosts

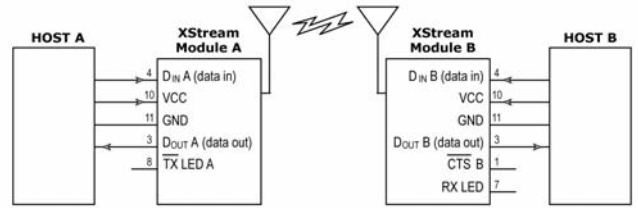

The data flow sequence is initiated when the first byte of data is received in the DI Buffer of the transmitting module (XStream Module A). As long as XStream Module A is not already receiving RF data, data in the DI Buffer is packetized, then transmitted over-the-air to XStream Module B.

1.4.1. Timing Specifications

Figure 1.3. Timing Specifications (“A” and “B” refer to Figure 1.2.)

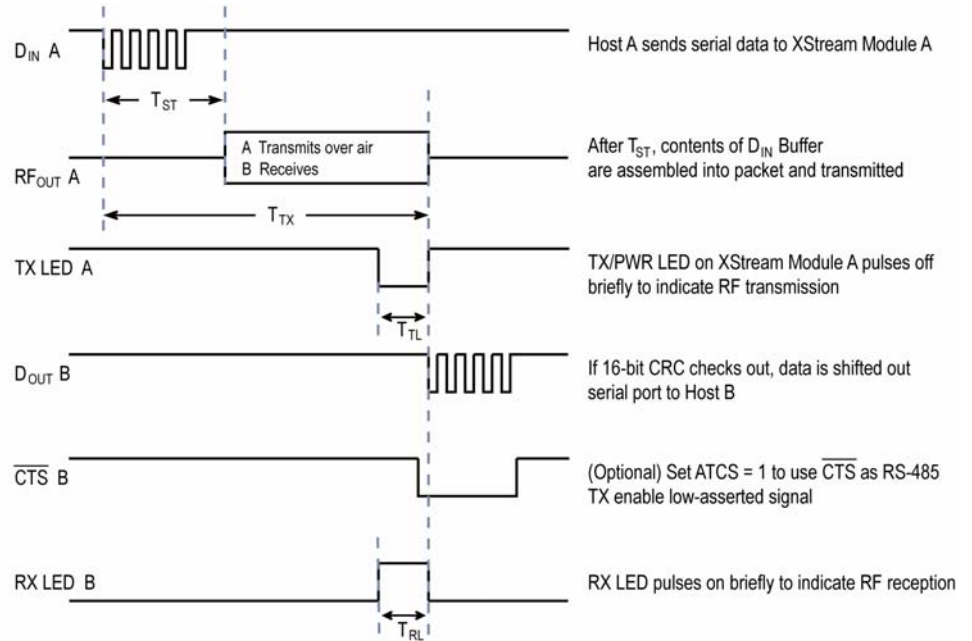

Table 1.4. AC Characteristics (SY parameter = 0, symbols correspond to Figure 1.2 and Figure 1.3.)

Symbol	Description	19200 baud rate (32 byte packet)	19200 timing (B=number of bytes)	9600 baud rate (32 byte packet)	9600 timing (B=number of bytes)
T _{TX}	Latency from the time data is transmitted until received	54.0 ms	For 0 < B < 64, T = 41.6 + (0.4 * B) ms For B > 63, T = 66.8 ms	72.0 ms	For 0 < B < 40, T = 46.27 + (0.73 * B) ms For B >= 39 bytes, T = 74.80 ms
T _{TL}	Time that TX/PWR pin is driven low	8.4 ms	For 0 < B < 14, T = 3.24 + (0.4 * B) ms For B > 13, T = 8.48 ms	16.8 ms	For 0 < B < 14, T = 6.50 + (0.8 * B) ms For B > 13, T = 16.80 ms
T _{RL}	Time that RX LED pin is driven high	13.6 ms	For 0 < B < 65, T = 0.79 + (0.408 * B) For B > 64, T = 26.9 ms	25.6 ms	For 0 < B < 37, T = 1.63 + (0.794 * B) For B > 36, T = 30.2 ms
T _{ST}	Channel Initialization Time	35.0 ms	35.0 ms	35.0 ms	35.0 ms

Table 1.5. DC Characteristics ($V_{CC} = 4.75 - 5.25$ VDC)

Symbol	Parameter	Condition	Min	Typical	Max	Units
V_{IL}	Input Low Voltage	All input signals	-0.5		$0.3 * V_{CC}$	V
V_{IH}	Input High Voltage	All except RESET pin	$0.6 * V_{CC}$		$V_{CC} + 0.5$	V
V_{IH2}	Input High Voltage	RESET pin *	$0.9 * V_{CC}$		$V_{CC} + 0.5$	V
V_{OL}	Output Low Voltage	$I_{OL} = 20$ mA, $V_{CC} = 5$ V			0.7 0.5	V
V_{OH}	Output High Voltage	$I_{OH} = -20$ mA, $V_{CC} = 5$ V	4.0 2.0			V
I_{IL}	Input Leakage Current I/O Pin	$V_{CC} = 5.5$ V, pin low (absolute value)			3	μ A
I_{IH}	Input Leakage Current I/O Pin	$V_{CC} = 5.5$ V, pin high (absolute value)			3	μ A
I_{IL2}		CTS, RESET, DO		$(V_{CC} - V_i) / 10$ **		mA
I_{IL3}		CONFIG		$(V_{CC} - V_i) / 47$ **		mA
I_{IH2}		RTS		$(V_{CC} - V_i) / 10$ **		mA

* Reset pulse must last at least 250 nanoseconds

** V_i = the input voltage on the pin

1.5. Mechanical Drawings

Figure 1.4. Mechanical Drawings - XStream Module w/ RPSMA Connector

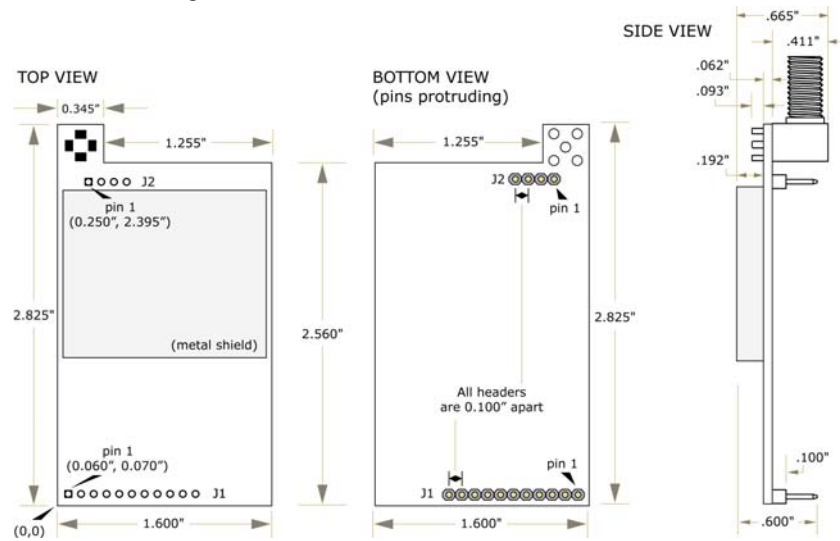
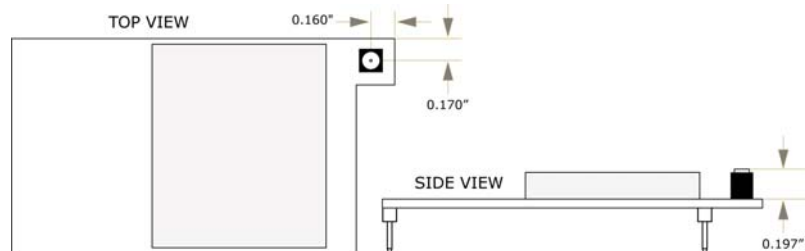

Figure 1.5. Mechanical Drawings - XStream Module w/ MMCX Connector
(Measurements not shown are identical to those shown in the RPSMA diagrams above.)



2. Module Operation

2.1. Serial Communications

The XStream OEM RF Module interfaces to a host device through a CMOS-level asynchronous serial port. Through its serial port, the module can communicate with any UART voltage compatible device or through a level translator to any RS-232/485/422 device.

2.1.1. UART-Interfaced Data Flow

Devices that have a UART interface can connect directly through the pins of the XStream Module as is shown in the figure below.

Figure 2.1. System Data Flow Diagram in a UART-interfaced environment

(Low-asserted signals distinguished with horizontal line over signal name.)

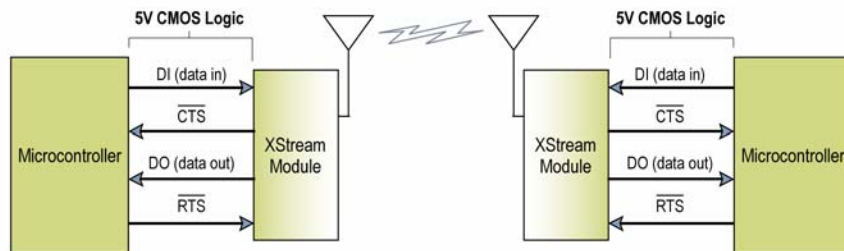

Serial Data

Data enters the XStream Module through the DI pin (pin 4) as an asynchronous serial signal. The signal should idle high when no data is being transmitted.

The UART performs tasks, such as timing and parity checking, that are needed for data communications. Serial communication consists of two UARTs configured with compatible parameters (baud rate, parity, start bits, stop bits, data bits) to have successful communication. Each data packet consists of a start bit (low), 8 data bits (least significant bit first) and a stop bit (high). The following figure illustrates the serial bit pattern of data passing through the module.

Figure 2.2. UART data packet 0x1F (decimal number “31”) as transmitted through the XStream Module

Example Data Format is 8-N-1 (bits – parity - # of stop bits)

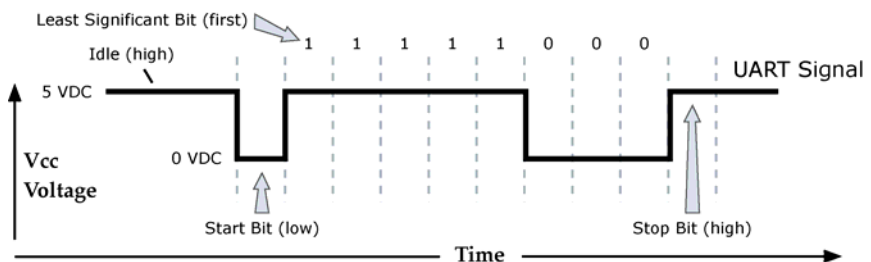

2.1.2. Flow Control

Figure 2.3. Internal Data Flow Diagram (The five most commonly-used pin signals shown.)

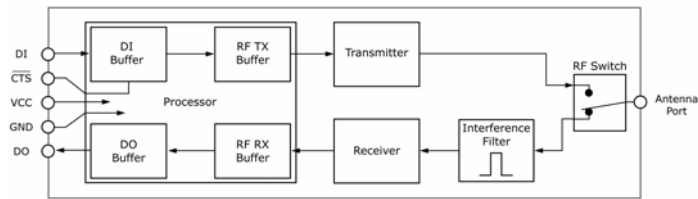

DI (Data In) Buffer and Flow Control

When serial data enters the XStream Module through the DI Pin, then the data is stored in the DI Buffer until it can be transmitted.

When the RO parameter threshold is satisfied (refer to Transmit Mode section [p11] and command descriptions [p17] for more information), the module attempts to initialize an RF connection. If the module is already receiving RF data, the serial data is stored in the module's DI Buffer. If the DI buffer becomes full, hardware or software flow control must be implemented in order to prevent overflow (loss of data between the host and XStream OEM RF Module).

How to eliminate the need for flow control:

1. Send messages that are smaller than the DI buffer size. The size of the DI buffer varies according to the packet size and parity setting used.
2. Interface at a lower baud rate (BD parameter) than the fixed RF data rate.

Two cases in which the DI Buffer may become full and possibly overflow:

1. If the serial interface data rate is set higher than the RF data rate of the module, the module will receive data from the host faster than it can transmit the data over-the-air.
2. If the module is receiving a continuous stream of RF data or if the module is monitoring data on a network, any serial data that arrives on the DI pin (Pin 4) is placed in the DI Buffer. The data in the DI buffer will be transmitted over-the-air when the module no longer detects RF data in the network.

Hardware Flow Control (CTS). When the DI buffer is 17 bytes away from being full; by default, the module de-asserts (high) $\overline{\text{CTS}}$ to signal to the host device to stop sending data [refer to FT (Flow Control Threshold) and CS (DO2 Configuration) Commands]. $\overline{\text{CTS}}$ is re-asserted after the DI Buffer has 34 bytes of memory available.

Software Flow Control (XON). XON/XOFF software flow control can be enabled using the FL (Software Flow Control) Command. This option only works with ASCII data.

DO (Data Out) Buffer and Flow Control

When RF data is received, the data enters the DO buffer and is then sent out the serial port to a host device. Once the DO Buffer reaches capacity, any additional incoming RF data is lost.

Two cases in which the DO Buffer may become full and possibly overflow:

1. If the RF data rate is set higher than the interface data rate of the module, the module will receive data from the transmitting module faster than it can send the data to the host.
2. If the host does not allow the module to transmit data out from the DO buffer because of being held off by hardware or software flow control.

Hardware Flow Control (RTS). If $\overline{\text{RTS}}$ is enabled for flow control (RT Parameter = 2), data will not be sent out the DO Buffer as long as $\overline{\text{RTS}}$ (pin 5) is de-asserted.

Software Flow Control (XOFF). XON/XOFF software flow control can be enabled using the FL (Software Flow Control) Command. This option only works with ASCII data.

2.2. Modes of Operation

XStream OEM RF Modules operate in five modes.

Figure 2.4. XStream Modes of Operation

The module can only be in one mode at a time.

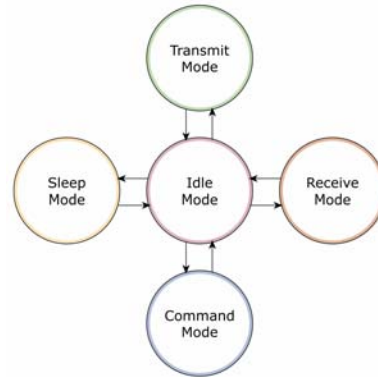

2.2.1. Idle Mode

When not receiving or transmitting data, the module is in Idle Mode. The module uses the same amount of power in Idle Mode as it does in Receive Mode.

The module shifts into the other modes of operation under the following conditions:

- Serial data is received in the DI Buffer (Transmit Mode)
- Valid RF data is received through the antenna (Receive Mode)
- Command Mode Sequence is issued (Command Mode)
- Sleep Mode condition is met (Sleep Mode)

After responding to any of the preceding conditions, the module automatically transitions back into Idle Mode.

2.2.2. Transmit Mode

When the first byte of serial data is received from the UART in the DI buffer, the module attempts to shift to Transmit Mode and initiate an RF connection with other modules.

Figure 2.5. Transmission of Data →

Once in Transmit Mode, the module initializes a communications channel. Channel initialization is the process of sending an RF initializer that synchronizes receiving modules with the transmitting module. When streaming multiple RF packets, the RF Initializer is only sent in front of the first packet. During channel initialization, incoming serial data accumulates in the DI buffer.

After the channel is initialized, data in the DI buffer is grouped into packets (up to 64 bytes in each packet) and is transmitted. The module continues to transmit data packets until the DI buffer is empty. Once transmission is finished, the module returns to Idle Mode. This progression is shown in Figure 2.5.

As the transmitting module nears the end of the transmission, it inspects the DI buffer to see if more data exists to be transmitted. This could be the case if more bytes arrived from the host after the transmission began. If more data is pending, the transmitting module assembles a subsequent packet for transmission.

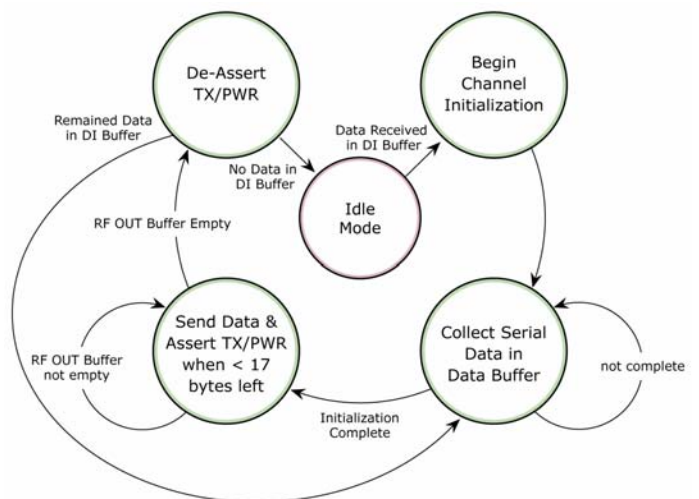

RF Packet

Figure 2.6. RF Packet Components

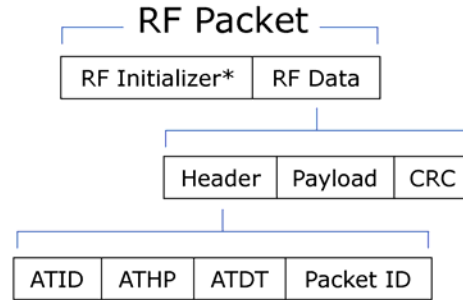

* When streaming multiple RF packets, the RF Initializer is only sent in front of the first packet.

RF Initializer

An RF initializer is sent each time a new connection sequence begins. The RF initializer contains channel information that notifies receiving modules of information such as the hopping pattern used by the transmitting module. The first transmission always sends an RF initializer.

An RF initializer can be of various lengths depending on the amount of time determined to be required to prepare a receiving module. For example, a wake-up initializer is a type of RF initializer used to wake remote modules from Sleep Mode (Refer to the FH, LH, HT and SM Commands for more information). The length of the wake-up initializer should be longer than the length of time remote modules are in cyclic sleep.

Header

The header contains network addressing information that filters incoming RF data. The receiving module checks for a matching VID, Hopping Channel and Destination Address. Data that does not pass through all three network filter layers is discarded.

Figure 2.7. Network Layers Contained in the Header

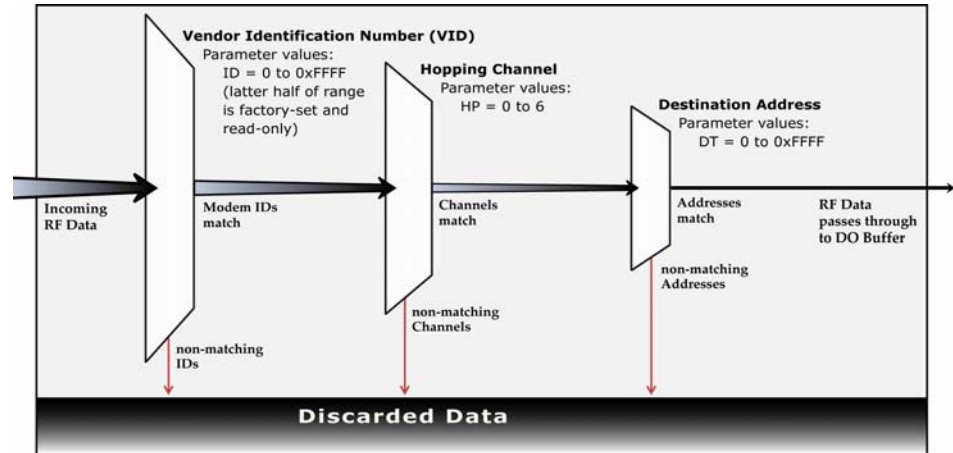

CRC (Cyclic Redundancy Check)

To verify data integrity and provide built-in error checking, a 16-bit CRC (Cyclic Redundancy Check) is computed for the transmitted data and attached to the end of each RF packet. On the receiving end, the receiving module computes the CRC on all incoming RF data. Received data that has an invalid CRC is discarded [See Receive Mode section, next page].

2.2.3. Receive Mode

If a module detects RF data while operating in Idle Mode, the module transitions into Receive Mode to start receiving RF packets.

Figure 2.8. Reception of RF Data →

After a packet is received, the module checks the CRC (cyclic redundancy check) to ensure that the data was transmitted without error. If the CRC data bits on the incoming packet are invalid, the packet is discarded. If the CRC is valid, the packet proceeds to the DO Buffer.

The module returns to Idle Mode after valid RF data is no longer detected or after an error is detected in the received RF data. If serial data is stored in the DI buffer while the module is in Receive Mode, the serial data will be transmitted after the module is finished receiving data and returns to Idle Mode.

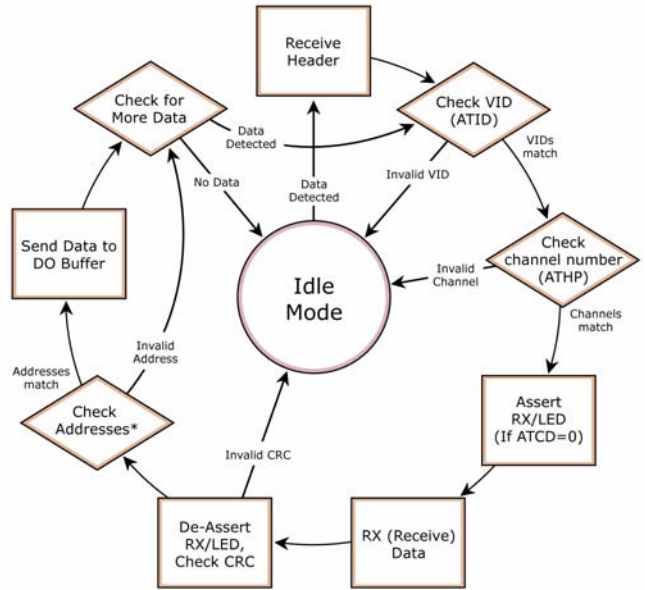

2.2.4. Sleep Mode

Sleep Modes enable the XStream Module to operate at minimal power consumption when not in use. Three Sleep Mode options are available:

- **Pin Sleep** (Host Controlled)
- **Serial Port Sleep** (Wake on Serial Port activity)
- **Cyclic Sleep** (Wake on RF activity)

For the module to transition into Sleep Mode, the module must have a non-zero SM (Sleep Mode) Parameter and one of the following must occur:

1. The module is idle (no data transmission or reception) for a user-defined period of time [See ST (Time before Sleep) Command].
2. SLEEP (pin 2) is asserted (only for Pin Sleep option).

In Sleep Mode, the module will not transmit or receive data until the module first transitions to Idle Mode. All Sleep Modes are enabled and disabled using SM Command. Transitions into and out of Sleep Modes are triggered by various events as shown in the table below.

Table 2.1. Summary of Sleep Mode Configurations

Sleep Mode Setting	Transition into Sleep Mode	Transition out of Sleep Mode	Related Commands	Typical Power Consumption
Pin Sleep (SM = 1)	Microcontroller can shut down and wake modules by asserting (high) SLEEP (pin 2). Note: The module will complete a transmission or reception before activating Pin Sleep.	De-assert (low) SLEEP (pin 2).	SM	26 µA
Serial Port Sleep (SM = 2)	Automatic transition to Sleep Mode occurs after a user-defined period of inactivity (no transmitting or receiving of data). The period of activity is defined using the ST (Time before Sleep) Command.	When serial byte is received on the DI pin (pin 4).	SM, ST	1 mA
Cyclic Sleep (SM = 3-8)	Automatic transition to Sleep Mode occurs in cycles as defined by the SM (Sleep Mode) Command. Note: The cyclic sleep time interval must be shorter than the "Wake-up Initializer Timer" (set by LH Command).	After the cyclic sleep time interval elapses. Note: Module can be forced into Idle Mode if PW (Pin Wake-up) Command is issued.	SM, ST, HT, LH, PW	76 µA when sleeping

For more information about Sleep Modes, refer to the individual commands listed in "Related Commands" column of the table. SM Command is the best starting point for implementing Sleep Mode configurations.

2.2.5. Command Mode

To modify or read module parameters, the module must first enter into Command Mode, the state in which incoming characters are interpreted as commands. Two command types are available for programming the module:

- AT Commands
- Binary Commands

For modified parameter values to persist in the module registry, changes must be saved to non-volatile memory using WR (Write) Command. Otherwise, parameters are restored to previously saved values after the module is powered off and then on again.

AT Commands

To Enter AT Command Mode:

1. Send the 3-character command sequence “+++” and observe guard times before and after the command characters. [Refer to the “Default AT Command Mode Sequence” below.] The “Terminal” tab (or other serial communications software) of the X-CTU Software can be used to enter the sequence.
[OR]
2. Assert (low) the **CONFIG** pin and either turn the power going to the module off and back on. (If using a MaxStream XIB-R Interface Board, the same result can be achieved by keeping the configuration switch pressed while turning off, then on again the power supplying the module assembly (module assembly = module mounted to an interface board))

Default AT Command Mode Sequence (for transition to Command Mode):

- No characters sent for one second [see BT (Guard Time Before) Command]
- Input three plus characters (“+++”) within one second [see CC (Command Sequence Character) Command.]
- No characters sent for one second [see AT (Guard Time After) Command.]

To Send AT Commands:

Send AT commands and parameters using the syntax shown below.

Figure 2.9. Syntax for sending AT Commands

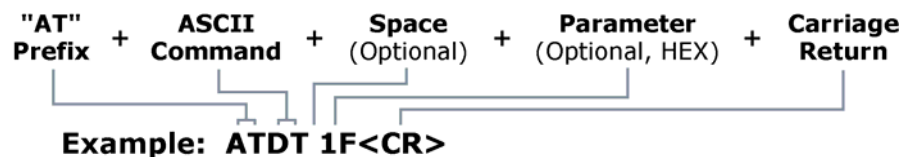

NOTE: To read a parameter value stored in a register, leave the parameter field blank.

The preceding example would change the module Destination Address to “0x1F”. To store the new value to non-volatile (long term) memory, subsequently send the Write (ATWR) Command.

System Response. When a command is sent to the module, the module will parse and execute the command. Upon successful execution of a command, the module returns an “OK” message. If execution of a command results in an error, the module returns an “ERROR” message.

To Exit AT Command Mode:

1. Send ATCN (Exit Command Mode) Command.
[OR]
2. If no valid AT Commands are received within the time specified by CT (Command Mode Timeout) Command, the Module automatically returns to Idle Mode.

For an example that illustrates programming the module using AT Commands, refer to the “Module Configuration” chapter [p16].

Binary Commands

Sending and receiving parameter values using binary commands is the fastest way to change operating parameters of the module. Binary commands are used most often to sample signal strength (RS parameter) and/or error counts; or to change module addresses and channels for polling systems when a quick response is necessary. Since the sending and receiving of parameter values takes place through the same data path as 'live' data (received RF payload), interference between the two types of data can be a concern.

Common questions about using binary commands:

- What are the implications of asserting CMD while live data is being sent or received?
- After sending serial data, is there a minimum time delay before CMD can be asserted?
- Is a time delay required after CMD is de-asserted before payload data can be sent?
- How to discern between live data and data received in response to a command?

CMD [pin 5] must be asserted in order to send binary commands to the module. The CMD pin can be asserted to recognize binary commands anytime during the transmission or reception of data. The status of the CMD signal is only checked at the end of the stop bit as the byte is shifted into the serial port. The application does not allow control over when data is received, except by waiting for dead time between bursts of communication.

If the command is sent in the middle of a stream of payload data to be transmitted, the command will essentially be executed in the order it is received. If the radio is continuously receiving data, the radio will wait for a break in the received data before executing the command. The CTS signal will frame the response coming from the binary command request [Figure 2.10].

A minimum time delay of 100 μs (after the stop bit of the command byte has been sent) must be observed before pin 5 can be de-asserted. The command executes after all parameters associated with the command have been sent. If all parameters are not received within 0.5 seconds, the module aborts the command and returns to Idle Mode.

Note: When parameters are sent, they are two bytes long with the least significant byte sent first. Binary commands that return one parameter byte must be written with two parameter bytes.

Refer to p16 for a binary programming example (DT command example returns two bytes)

Commands can be queried for their current value by sending the command logically ORed (bit-wise) with the value 0x80 (hexadecimal) with CMD asserted. When the binary value is sent (with no parameters), the current value of the command parameter is sent back through the DO pin.

Figure 2.10. Binary Command Write then Read

- Signal #4 is CMD (pin 5)
- Signal #1 is the DIN (pin 4) signal to the radio
- Signal #2 is the DOUT (pin 3) signal from the radio
- Signal #3 is CTS (pin 1)

In this graph, a value was written to a register and then read out to verify it. While not in the middle of other received data, note that the CTS signal outlines the data response out of the module.

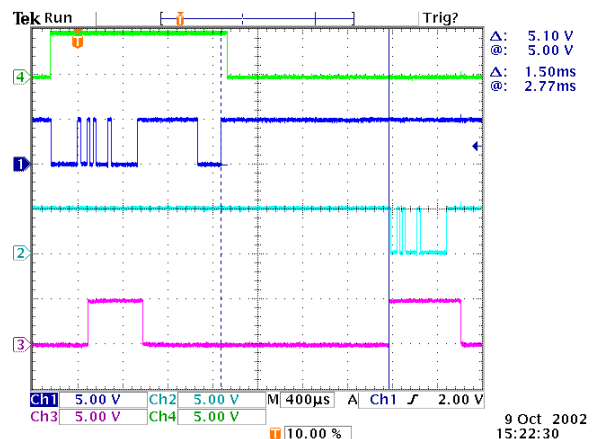

9 Oct 2002
15:22:30

IMPORTANT: For the XStream Module to recognize a binary command, the RT (DI2 Configuration) parameter must be set to one. If binary programming is not enabled (RT ≠ 1), the module will not recognize that the CMD pin (Pin 5) is asserted and therefore will not recognize the data as binary commands.

3. Module Configuration

3.1. Hands-on Programming Examples

For information about entering and exiting AT and Binary Command Modes, refer to the Command Mode section [p14].

3.1.1. AT Command Example

To Send AT Commands (Using the Terminal tab of MaxStream's X-CTU Software)

Example: Both of the following examples change the module's destination address to 0x1A0D and save the new address to non-volatile memory.

Method 1 (One line per command)

Send AT Command

```
+++
ATDT <Enter>
ATDT1A0D <Enter>
ATWR <Enter>
ATCN <Enter>
```

System Response

```
OK <CR> (Enter into Command Mode)
0 <CR> (Read current destination address)
OK <CR> (Change destination address)
OK <CR> (Write to non-volatile memory)
OK <CR> (Exit Command Mode)
```

Method 2 (Multiple commands on one line)

Send AT Command

```
+++
ATDT <Enter>
ATDT1A0D,WR,CN <Enter>
```

System Response

```
OK <CR> (Enter into Command Mode)
0 <CR> (Read current destination address)
OK <CR> (Execute commands)
```

MaxStream provides X-CTU Software for programming the module using standard AT Commands.

To install, double-click the "setup_X-CTU.exe" file (located on the MaxStream CD & on the web - www.maxstream.net), then follow the prompts of the installation screens.

Note: In order to use a host PC and the X-CTU Software Terminal tab to send data to the module, the PC com port settings must match the following module parameter values: baud, parity & stop bits.

Use the "PC Settings" tab to configure PC com port settings to match module parameter values.

3.1.2. Binary Command Example

To Send Binary Commands:

Example: Use binary commands to change the XStream Module's destination address to 0x1A0D and save the new address to non-volatile memory.

1. RT Command must be set to "1" in AT Command Mode to enable binary programming.
2. Assert CMD (Pin 5 is driven high). (Enter Binary Command Mode)
3. Send Bytes (parameter bytes must be 2 bytes long):

00	(Send DT (Destination Address) Command)
0D	(Least significant byte of parameter bytes)
1A	(Most significant byte of parameter bytes)
08	(Send WR (Write) Command)
4. De-assert CMD (Pin 5 is driven low) (Exit Binary Command Mode)

Note: \overline{CTS} (pin 1) is de-asserted high when commands are being executed. Hardware flow control must be disabled as \overline{CTS} will hold off parameter bytes.

3.2. Command Reference

Table 3.1. XStream Commands

(The XStream Module expects numerical values in hexadecimal. “d” denotes decimal equivalent.)

AT Command	Binary Command	AT Command Name	Range	Command Category	# Bytes Returned	Factory Default
AT	0x05 (5d)	Guard Time After	0x02 – 0xFFFF [x 100 msec]	Command Mode Options	2	0x0A (10d)
BD v4.2B*	0x15 (21d)	Baud Rate	Standard baud rates: 0 – 6 Non-standard baud rates: 0x7D – 0xFFFF	Serial Interfacing	2	Set to equal factory-set RF data rate
BT	0x04 (4d)	Guard Time Before	2 – 0xFFFF [x 100 msec]	Command Mode Options	2	0x0A (10d)
CC	0x13 (19d)	Command Sequence Character	0x20 – 0x7F	Command Mode Options	1	0x2B (“+”)
CD v 4.2B*	0x28 (40d)	DO3 Configuration	0 - 3	Serial Interfacing	1	0
CN	0x09 (9d)	Exit AT Command Mode	-	Command Mode Options	-	-
CS v 4.27D*	0x1F (31d)	DO2 Configuration	0 – 4	Serial Interfacing	1	0
CT	0x06 (6d)	Command Mode Timeout	0x02 – 0xFFFF [x 100 msec]	Command Mode Options	2	0xC8 (200d)
DT	0x00 (0d)	Destination Address	0 – 0xFFFF	Networking	2	0
E0	0x0A (10d)	Echo Off	-	Command Mode Options	-	-
E1	0x0B (11d)	Echo On	-	Command Mode Options	-	-
ER	0x0F (15d)	Receive Error Count	0 – 0xFFFF	Diagnostics	2	0
FH	0x0D (13d)	Force Wake-up Initializer	-	Sleep (Low Power)	-	-
FL	0x07 (7d)	Software Flow Control	0 – 1	Serial Interfacing	1	0
FT v 4.27B*	0x24 (36d)	Flow Control Threshold	0 – 0xFF [bytes]	Serial Interfacing	2	varies
GD	0x10 (16d)	Receive Good Count	0 – 0xFFFF	Diagnostics	2	0
HP	0x11 (17d)	Hopping Channel	0 – 6	Networking	1	0
HT	0x03 (3d)	Time before Wake-up Initializer	0 – 0xFFFF [x 100 msec]	Sleep (Low Power)	2	0xFFFF
ID v 4.2B*	0x27 (39d)	Module VID	User settable: 0x10 - 0x7FFF Read-only: 0x8000 – 0xFFFF	Networking	2	-
LH	0x0C (12d)	Wake-up Initializer Timer	0 – 0xFF [x 100 msec]	Sleep (Low Power)	1	1
MK	0x12 (18d)	Address Mask	0 – 0xFFFF	Networking	2	0xFFFF
NB v 4.27B*	0x23 (35d)	Parity	0 – 4	Serial Interfacing	1	0
PC v 4.22*	0x1E (30d)	Power-up Mode	0 – 1	Command Mode Options	1	0
PW v 4.22*	0x1D (29d)	Pin Wake-up	0 – 1	Sleep (Low Power)	1	0
RE	0x0E (14d)	Restore Defaults	-	(Special)	-	-
RN v 4.22*	0x19 (25d)	Delay Slots	0 – 0xFF [slots]	Networking	1	0
RO v 4.2AA*	0x21 (33d)	Packetization Timeout	0 – 0xFFFF [x 200 µsec]	Serial Interfacing	2	0
RP v 4.2AA*	0x22 (34d)	RSSI PWM Timer	0 - 0x7F [x 100 msec]	Diagnostics	1	0
RR v 4.22*	0x18 (24d)	Retries	0 – 0xFF	Networking	1	0
RS v 4.22*	0x1C (28d)	RSSI	0x06 – 0x36 [read-only]	Diagnostics	1	-
RT	0x16 (22d)	DI2 Configuration	0 - 2	Serial Interfacing	1	0
SB v4.2B*	0x36 (54d)	Stop Bits	0 - 1	Serial Interfacing	1	0
SH v 4.27C*	0x25 (37d)	Serial Number High	0 – 0xFFFF [read-only]	Diagnostics	2	-
SL v 4.27C*	0x26 (38d)	Serial Number Low	0 – 0xFFFF [read-only]	Diagnostics	2	-
SM	0x01 (1d)	Sleep Mode	0 – 8	Sleep (Low Power)	1	0
ST	0x02 (2d)	Time before Sleep	0x10 – 0xFFFF [x 100 msec]	Sleep (Low Power)	2	0x64 (100d)
SY	0x17 (23d)	Time before Initialization	0 – 0xFF [x 100 msec]	Networking	1	0 (disabled)
TR v 4.22*	0x1B (27d)	Transmit Error Count	0 – 0xFFFF	Diagnostics	2	0
TT v 4.22*	0x1A (26d)	Streaming Limit	0 – 0xFFFF [0 = disabled]	Networking	2	0xFFFF
VR	0x14 (20d)	Firmware Version	0 x 0xFFFF [read-only]	Diagnostics	2	-
WR	0x08 (8d)	Write	-	(Special)	-	-

* Firmware version in which command and parameter options were first supported.

NOTE: AT Commands issued without a parameter value will return the currently stored parameter.

3.3. Command Descriptions

Commands in this section are listed alphabetically. Command categories are designated between the "< >" symbols that follow each command title. XStream Modules expect numerical values in hexadecimal and those values are designated by a "0x" prefix.

AT (Guard Time After) Command

<Command Mode Options> AT Command is used to set the time-of-silence that follows the command sequence character (CC Command). By default, AT Command Mode will activate after one second of silence.

Refer to the AT Commands section [p14] to view the default AT Command Mode Sequence.

AT Command: ATAT
Binary Command: 0x05 (5 decimal)
Parameter Range: 0x02 - 0xFFFF [x 100 milliseconds]
Number of bytes returned: 2
Default Parameter Value: 0x0A (10 decimal)
Related Commands: BT (Guard Time Before), CC (Command Sequence Character)

BD (Baud Rate) Command

<Serial Interfacing> BD Command allows the user to adjust the UART interface data rate and thus modify the rate at which serial data is sent to the module. The new baud rate does not take effect until the CN (Exit AT Command Mode) Command is issued. The RF data rate is not affected by the BD Command.

Although most applications will only require one of the seven standard baud rates, non-standard baud rates are also supported.

Note: If the serial data rate is set to exceed the fixed RF data rate of the XStream module, CTS flow control may need to be implemented as described in the Pin Signals and Flow Control sections of this manual.

Non-standard Interface Data Rates: When parameter values outside the range of standard baud rates are sent, the closest interface data rate represented by the number is stored in the BD register. For example, a rate of 19200 bps can be set by sending the following command line "ATBD4B00". NOTE: When using MaxStream's X-CTU Software, non-standard interface data rates can only be set and read using the X-CTU 'Terminal' tab. Non-standard rates are not accessible through the 'Modem Configuration' tab.

When the BD command is sent with a non-standard interface data rate, the UART will adjust to accommodate the requested interface rate. In most cases, the clock resolution will cause the stored BD parameter to vary from the parameter that was sent (refer to the table below). Reading the BD command (send "ATBD" command without an associated parameter value) will return the value that was actually stored to the BD register.

Table 3.2. Parameter Sent vs. Parameter Stored

BD Parameter Sent (HEX)	Interface Data Rate (bps)	BD Parameter Stored (HEX)
0	1200	0
4	19,200	4
7	115,200	7
12C	300	12B
1C200	115,200	1B207

AT Command: ATBD																
Binary Command: 0x15 (21 decimal)																
Parameter Range (Standard baud rates): 0 - 6 (Non-standard baud rates): 0x7D - 0xFFFF																
<table border="1"> <thead> <tr> <th>Parameter Value</th> <th>BAUD (bps) Configuration</th> </tr> </thead> <tbody> <tr> <td>0</td> <td>1200</td> </tr> <tr> <td>1</td> <td>2400</td> </tr> <tr> <td>2</td> <td>4800</td> </tr> <tr> <td>3</td> <td>9600</td> </tr> <tr> <td>4</td> <td>19200</td> </tr> <tr> <td>5</td> <td>38400</td> </tr> <tr> <td>6</td> <td>57600</td> </tr> </tbody> </table>	Parameter Value	BAUD (bps) Configuration	0	1200	1	2400	2	4800	3	9600	4	19200	5	38400	6	57600
Parameter Value	BAUD (bps) Configuration															
0	1200															
1	2400															
2	4800															
3	9600															
4	19200															
5	38400															
6	57600															
Number of bytes returned: 2																
Default Parameter Value: Set to equal module's factory-set RF data rate.																
Minimum firmware version required: 4.2B (non-standard baud rates not previously supported)																

BT (Guard Time Before) Command

<Command Mode Options> BT Command is used to set the DI pin silence time that must precede the command sequence character (CC Command) of the AT Command Mode Sequence.

Refer to the AT Commands section [p14] to view the default AT Command Mode Sequence.

AT Command: ATBT
Binary Command: 0x04 (4 decimal)
Parameter Range: 2 – 0xFFFF [x 100 milliseconds]
Default Parameter Value: 0x0A (10 decimal)
Number of bytes returned: 2
Related Commands: AT (Guard Time After), CC (Command Sequence Character)

CC (Command Sequence Character) Command

<Command Mode Options> CC Command is used to set the ASCII character to be used between Guard Times of the AT Command Mode Sequence (BT+ CC + AT). The AT Command Mode Sequence activates AT Command Mode (from Idle Mode).

Refer to the AT Commands section [p14] to view the default AT Command Mode Sequence.

AT Command: ATCC
Binary Command: 0x13 (19 decimal)
Parameter Range: 0x20 – 0x7F
Default Parameter Value: 0x2B (ASCII “+” sign)
Number of bytes returned: 1
Related Commands: AT (Guard Time After), BT (Guard Time Before)

CD (DO3 Configuration) Command

<Command Mode Options> CD Command is used to redefine the behavior of the DO3/RX LED line.

AT Command: ATCD										
Binary Command: 0x28 (40 decimal)										
Parameter Range: 0 – 2										
<table border="1"> <thead> <tr> <th>Parameter Value</th> <th>Configuration</th> </tr> </thead> <tbody> <tr> <td>0</td> <td>RX LED</td> </tr> <tr> <td>1</td> <td>Default high</td> </tr> <tr> <td>2</td> <td>Default low</td> </tr> <tr> <td>3</td> <td>Assert only when packet addressed to module sent</td> </tr> </tbody> </table>	Parameter Value	Configuration	0	RX LED	1	Default high	2	Default low	3	Assert only when packet addressed to module sent
Parameter Value	Configuration									
0	RX LED									
1	Default high									
2	Default low									
3	Assert only when packet addressed to module sent									
Default Parameter Value: 0										
Number of bytes returned: 1										
Minimum Firmware Version Required: 4.2B										

CN (Exit AT Command Mode) Command

<Command Mode Options> CN Command is used to explicitly exit AT Command Mode.

AT Command: ATCN
Binary Command: 0x09 (9 decimal)

CS (DO2 Configuration) Command

<Serial Interfacing> CS Command is used to select the behavior of the DO2 pin signal. This output can provide RS-232 flow control, control the TX enable signal (for RS-485 or RS-422 operations), or set the default level for the I/O line passing function.

By default, DO2 provides RS-232 $\overline{\text{CTS}}$ (Clear-to-Send) flow control.

AT Command: ATCS												
Binary Command: 0x1F (31 decimal)												
Parameter Range: 0 – 4												
<table border="1"> <thead> <tr> <th>Parameter Value</th> <th>Configuration</th> </tr> </thead> <tbody> <tr> <td>0</td> <td>RS-232 $\overline{\text{CTS}}$ flow control</td> </tr> <tr> <td>1</td> <td>RS-485 TX enable low</td> </tr> <tr> <td>2</td> <td>high</td> </tr> <tr> <td>3</td> <td>RS-485 TX enable high</td> </tr> <tr> <td>4</td> <td>low</td> </tr> </tbody> </table>	Parameter Value	Configuration	0	RS-232 $\overline{\text{CTS}}$ flow control	1	RS-485 TX enable low	2	high	3	RS-485 TX enable high	4	low
Parameter Value	Configuration											
0	RS-232 $\overline{\text{CTS}}$ flow control											
1	RS-485 TX enable low											
2	high											
3	RS-485 TX enable high											
4	low											
Default Parameter Value: 0												
Number of bytes returned: 1												
Related Commands: RT (DI2 Configuration), TO (DO2 Timeout)												
Minimum Firmware Version Required: 4.27D												

CT (Command Mode Timeout) Command

<Command Mode Options> CT Command sets the amount of time before AT Command Mode terminates automatically. After a CT time of inactivity, the module exits AT Command Mode and returns to Idle Mode. AT Command Mode can also be exited manually using CN (Exit AT Command Mode) Command.

AT Command: ATCT
 Binary Command: 0x06 (6 decimal)
 Parameter Range: 0x02 – 0xFFFF
 [x 100 milliseconds]
 Default Parameter Value: 0xC8 (200 decimal, 20 seconds)
 Number of bytes returned: 2

DT (Destination Address) Command

<Networking> DT Command is used to set the networking address of an XStream Module. XStream Modules uses three network layers – Vendor Identification Number (ATID), Channels (ATHP), and Destination Addresses (ATDT). DT Command assigns an address to a module that enables it to communicate only with other modules having the same addresses. All modules that share the same Destination Address can communicate freely with each other. Modules in the same network with a different Destination Address (than that of the transmitter) will listen to all transmissions to stay synchronized, but will not send any of the data out their serial ports.

AT Command: ATDT
 Binary Command: 0x00
 Parameter Range: 0 – 0xFFFF
 Default Parameter Value: 0
 Number of bytes returned: 2
 Related Commands: HP (Hopping Channel), ID (Module VID), MK (Address Mask)

E0 (Echo Off) Command

<Command Mode Options> E0 Command turns off character echo in AT Command Mode. By default, echo is off.

AT Command: ATE0
 Binary Command: 0x0A (10 decimal)

E1 (Echo On) Command

<Command Mode Options> E1 Command turns on the echo in AT Command Mode. Each typed character will be echoed back to the terminal when ATE1 is active. E0 is the default.

AT Command: ATE1
 Binary Command: 0x0B (11 decimal)

ER (Receive Error Count) Command

<Diagnostics> Set/Read the receive-error. The error-count records the number of packets partially received then aborted on a reception error. This value returns to 0 after a reset and is not non-volatile (Value does not persist in the module’s memory after a power-up sequence). Once the “Receive Error Count” reaches its maximum value (up to 0xFFFF), it remains at its maximum count value until the maximum count value is explicitly changed or the module is reset.

AT Command: ATER
 Binary Command: 0x0F (15 decimal)
 Parameter Range: 0 – 0xFFFF
 Default Parameter Value: 0
 Number of bytes returned: 2
 Related Commands: GD (Receive Good Count)

FH (Force Wake-up Initializer) Command

<Sleep (Low Power)> FH Command is used to force a Wake-up Initializer to be sent on the next transmit. WR (Write) Command does not need to be issued with FH Command.

AT Command: ATFH
 Binary Command: 0x0D (13 decimal)

Use only with cyclic sleep modes active on remote modules.

FL (Software Flow Control) Command

<Serial Interfacing> FL Command is used to configure software flow control. Hardware flow control is implemented with the XStream Module as the DO2 pin ($\overline{\text{CTS}}$), which regulates when serial data can be transferred to the module. FL Command can be used to allow software flow control to also be enabled. XON character used is 0x11 (17 decimal). XOFF character used is 0x13 (19 decimal).

AT Command: ATFL

Binary Command: 0x07 (7 decimal)

Parameter Range: 0 – 1

Parameter Value	Configuration
0	Disable software flow control
1	Enable software flow control

Default Parameter Value: 0

Number of bytes returned: 1

FT (Flow Control Threshold) Command

<Serial Interfacing> Set/Read the flow control threshold. When FT bytes have accumulated in the DI buffer, $\overline{\text{CTS}}$ is de-asserted or the XOFF software flow control character is transmitted.

AT Command: ATFT

Binary Command: 0x24 (36 decimal)

Parameter Range: 0 – (Receiving module DO buffer size minus 0x11 bytes)

Default Parameter Value: Receiving module DO Buffer size minus 0x11

Number of bytes returned: 2

Minimum Firmware Version Required: 4.27B

GD (Receive Good Count) Command

<Diagnostics> Set/Read the count of good received RF packets. Parameter value is reset to 0 after every reset and is not non-volatile (Value does not persist in the module's memory after a power-up sequence). Once the "Receive Good Count" reaches its maximum value (up to 0xFFFF), it remains at its maximum count value until the maximum count value is manually changed or the module is reset.

AT Command: ATGD

Binary Command: 0x10 (16 decimal)

Parameter Range: 0 – 0xFFFF

Default Parameter Value: 0

Number of bytes returned: 2

Related Commands: ER (Receive Error Count)

HP (Hopping Channel) Command

<Networking> HP Command is used to set the module's hopping channel number. A channel is one of three layers of addressing available to the XStream module. In order for modules to communicate with each other, the modules must have the same channel number since each network uses a different hopping sequence. Different channels can be used to prevent modules in one network from listening to transmissions of another.

AT Command: ATHP

Binary Command: 0x11 (17 decimal)

Parameter Range: 0 – 6

Default Parameter Value: 0

Number of bytes returned: 1

Related Commands: DT (Destination Address), ID (Module VID), MK (Address Mask)

HT (Time before Wake-up Initializer) Command

<Sleep (Low Power)> If any modules within range are running in a “Cyclic Sleep” setting, a wake-up initializer must be used by the transmitting module for sleeping modules to remain awake [refer to the LH (“Wake-up Initializer Timer”) Command]. When a receiving module in Cyclic Sleep wakes, it must detect the wake-up initializer in order to remain awake and receive data. The value of HT Parameter tells the transmitter, “After a period of inactivity (no transmitting or receiving) lasting HT amount of time, send a long wake-up initializer”. HT Parameter should be set to match the inactivity timeout [specified by ST (Time before Sleep) Command] used by the receiver(s).

From the receiving module perspective, after HT time elapses and the inactivity timeout [ST Command] is met, the receiver goes into cyclic sleep. In cyclic sleep, the receiver wakes once per sleep interval to check for a wake-up initializer. When a wake-up initializer is detected, the module will stay awake to receive data. The wake-up initializer must be longer than the cyclic sleep interval to ensure that sleeping modules detect incoming data. When HT time elapses, the transmitter then knows that it needs to send a long Wake-up Initializer for all receivers to be able to remain awake and receive the next transmission. Matching HT to the time specified by ST on the receiving module guarantees that all receivers will detect the next transmission.

AT Command: ATHT
Binary Command: 0x03 (3 decimal)
Parameter Range: 0 – 0xFFFF [x 100 milliseconds]
Default Parameter Value: 0xFFFF (means that long wake-up initializer will not be sent)
Number of bytes returned: 2
Related Commands: LH (Wake-up Initializer Timer), SM (Sleep Mode), ST (Time before Sleep)

ID (Modem VID) Command

<Networking> Set/Read the “Vendor Identification Number”. Only modems with matching IDs can communicate with each other. Modules with non-matching VIDs will not receive unintended data transmission.

AT Command: ATID
Binary Command: 0x27 (39 decimal)
Parameter Range (user-settable): 0x10 – 0x7FFF (Factory-set and read-only): 0x8000 – 0xFFFF
Number of bytes returned: 2
Minimum Firmware Version Required: 4.2B

LH (Wake-up Initializer Timer) Command

<Sleep (Low Power)> LH Command adjusts the duration of time for which the RF initializer is sent. When receiving modules are put into Cyclic Sleep Mode, they power-down after a period of inactivity [specified by ST (Time before Sleep) Command] and will periodically awaken and listen for transmitted data. In order for the receiving modules to remain awake, they must detect ~35ms of the wake-up initializer.

LH Command must be used whenever a receiver is operating in Cyclic Sleep Mode. This lengthens the Wake-up Initializer to a specific amount of time (in tenths of a second). The Wake-up Initializer Time must be longer than the cyclic sleep time that is determined by SM (Sleep Mode) Command. If the wake-up initializer time were less than the Cyclic Sleep interval, the connection would be at risk of missing the wake-up initializer transmission.

Refer to Figures 3.1 & 3.2 of the SM Command description to view diagrams of correct and incorrect configurations. The images help visualize the importance that the value of LH be greater than the value of SM.

AT Command: ATLH
Binary Command: 0x0C (12 decimal)
Parameter Range: 0 – 0xFF [x 100 milliseconds]
Default Parameter Value: 1
Number of bytes returned: 1
Related Commands: HT (Time before Wake-up Initializer), SM (Sleep Mode), ST (Time before Sleep)

MK (Address Mask) Command

<Networking> MK Command is used to set/read the Address Mask.

All data packets contain the Destination Address of the transmitting module. When an RF data packet is received, the transmitter’s Destination Address is logically “ANDed” (bitwise) with the Address Mask of the receiver. The resulting value must match the Destination Address or the Address Mask of the receiver for the packet to be received and sent out the module’s DO serial port. If the “ANDed” value does not match either the Destination Address or the Address Mask of the receiver, the packet is discarded. (All “0” values are treated as “irrelevant” values and are ignored.)

AT Command: ATMK
 Binary Command: 0x12 (18 decimal)
 Parameter Range: 0 – 0xFFFF
 Default Parameter Value: 0xFFFF
 (Destination address (DT parameter) of the transmitting module must exactly match the destination address of the receiving module.)
 Number of bytes returned: 2
 Related Commands: DT (Destination Address), HP (Hopping Channel), ID (Module VID), MY (Source Address)

NB (Parity) Command

<Serial Interfacing> Select/Read parity settings for UART communications.

AT Command: ATNB
 Binary Command: 0x23 (35 decimal)
 Parameter Range: 0 – 4

Parameter Value	Configuration
0	8-bit (no parity or 7-bit (any parity))
1	8-bit even
2	8-bit odd
3	8-bit mark
4	8-bit space

Default Parameter Value: 0
 Number of bytes returned: 1
 Minimum Firmware Version Required: 4.27B

PC (Power-up to AT Mode) Command

<Command Mode Options> PC Command allows the module to power-up directly into AT Command Mode from reset or power-on. If PC Command is enabled with SM Parameter set to 1, DI3 (pin 2) can be used to enter the module into AT Command Mode. When the DI3 pin is de-asserted (low), the module will wake-up in AT Command Mode. This behavior allows module DTR emulation.

AT Command: ATPC
 Binary Command: 0x1E (30 decimal)
 Parameter Range: 0 – 1

Parameter Value	Configuration
0	Power-up to Idle Mode
1	Power-up to AT Command Mode

Default Parameter Value: 0
 Number of bytes returned: 1
 Minimum Firmware Version Required: 4.22

PW (Pin Wake-up) Command

<Sleep (Low Power)> Under normal operation, a module in Cyclic Sleep Mode cycles from an active state to a low-power state at regular intervals until data is ready to be received. If the PW Parameter is set to 1, SLEEP (pin 2) can be used to wake the module from Cyclic Sleep. If the SLEEP pin is de-asserted (low), the module will be fully operational and will not go into Cyclic Sleep. Once SLEEP is asserted, the module will remain active for the period of time specified by ST (Time before Sleep) Command, and will return to Cyclic Sleep Mode (if no data is ready to be transmitted). PW Command is only valid if Cyclic Sleep has been enabled.

AT Command: ATPW

Binary Command: 0x1D (29 decimal)

Parameter Range: 0 – 1

Parameter Value	Configuration
0	Disabled
1	Enabled

Default Parameter Value: 0

Number of bytes returned: 1

Related Commands: SM (Sleep Mode), ST (Time before Sleep)

Minimum Firmware Version Required: 4.22

RE (Restore Defaults) Command

<Diagnostics> RE Command restores all configurable parameters to factory default settings. However, RE Command will not write the default values to non-volatile (persistent) memory. Unless the WR (Write) Command is issued after the RE command, the default settings will not be saved in the event of module reset or power-down.

AT Command: ATRE

Binary Command: 0x0E (14 decimal)

RN (Delay Slots) Command

<Networking> RN Command is only applicable if retries have been enabled [RR (Retries) Command], or if forced delays will be inserted into a transmission [see TT (Streaming Limit) Command]. RN Command is used to adjust the time delay that the transmitter inserts before attempting to resend a packet. If the transmitter fails to receive an acknowledgement after sending a packet, it will insert a random number of delay slots (ranging from 0 to (RN minus 1)) before attempting to resend the packet. Each delay slot lasts for a period of 38ms.

AT Command: ATRN

Binary Command: 0x19 (25 decimal)

Parameter Range: 0 – 0xFF [slots]

Default Parameter Value: 0 (no delay slots inserted)

Number of bytes returned: 1

Related Commands: RR (Retries), TT (Streaming Limit)

Minimum Firmware Version Required: 4.22

If two modules attempted to transmit at the same time, the random time delay after packet failure would allow one of the two modules to transmit the packet successfully, while the other would wait until the channel opens up to begin transmission.

RO (Packetization Timeout) Command

<Serial Interfacing> RO Command is used to specify/read the time of silence (no bytes received) after which transmission begins. After a serial byte is received and if no other byte is received before the RO timeout, the transmission will start.

AT Command: ATRO

Binary Command: 0x21 (33 decimal)

Parameter Range: 0 – 0xFFFF [x 200 μs]

Default Parameter Value: 0

Number of bytes returned: 2

Minimum Firmware Version Required: 4.2AA

RP (RSSI PWM Timer) Command

<Diagnostics> RP Command is used to enable a PWM (“Pulse Width Modulation”) output on the Config pin which is calibrated to show the level the received RF signal is above the sensitivity level of the module. The PWM pulses vary from zero to 95 percent. Zero percent means the received RF signal is at or below the published sensitivity level of the module. The following table shows levels above sensitivity and PWM values.

The total period of the PWM output is 8.32 ms. There are 40 steps in the PWM output and therefore the minimum step size is 0.208 ms.

dBm above Sensitivity	PWM percentage (high period / total period)
10	47.5
20	62.5
30	77.5

A non-zero value defines the time that the PWM output will be active with the RSSI value of the last received RF packet. After the set time when no RF packets are received, the PWM output will be set low (0 percent PWM) until another RF packet is received. The PWM output will also be set low at power-up. A parameter value of 0xFF permanently enables the PWM output and it will always reflect the value of the last received RF packet.

PWM output shares the Config input pin. When the module is powered, the Config pin will be an input. During the power-up sequence, the Config pin will be read to determine whether the module is going into AT Command Mode. After this, if RP parameter is a non-zero value, the Config pin will be configured as an output and set low until the first RF packet is received. With a non-zero RP parameter, the Config pin will be an input for RP ms after power up.

AT Command: ATRP

Binary Command: 0x22 (34 decimal)

Parameter Range: 0 – 0x7F
[x 100 milliseconds]

Default Parameter Value: 0 (disabled)

Number of bytes returned: 1

Minimum Firmware Version Required: 4.2AA

RR (Retries) Command

Networking> RR Command specifies the number of retries that can be sent for a given RF packet. Once RR Command is enabled (set to a non-zero value), RF packet acknowledgements and retries are enabled. After transmitting a packet, the transmitter will wait to receive an acknowledgement from a receiver. If the acknowledgement is not received in the period of time specified by the RN (Delay Slots) Command, the transmitter will transmit the original packet again. The packet will be transmitted repeatedly until an acknowledgement is received or until the packet has been sent RR times.

Note: For retries to work correctly, all modules in the system must have retries enabled.

AT Command: ATRR

Binary Command: 0x18 (24 decimal)

Parameter Range: 0 – 0xFF

Default Parameter Value: 0 (disabled)

Number of bytes returned: 1

Minimum Firmware Version Required: 4.22

RS (RSSI) Command

<Diagnostics> RS Command returns the signal level of the last packet received. This reading is useful for determining range characteristics of the XStream Modules under various conditions of noise and distance.

Once the command is issued, the module will return a value between 0x6 and 0x36 where 0x36 represents a very strong signal level and 0x4 indicates a low signal level.

AT Command: ATRS

Binary Command: 0x1C (28 decimal)

Parameter Range: 0x06 – 0x36 [read-only]

Number of bytes returned: 1

Minimum Firmware Version Required: 4.22

RT (DI2 Configuration) Command

<Serial Interfacing> RT command is used to dictate the behavior of the DI2/ $\overline{\text{RTS}}$ /CMD line. RT Command must be issued to enable $\overline{\text{RTS}}$ flow control or binary programming.

AT Command: ATRT
 Binary Command: 0x16 (22 decimal)
 Parameter Range: 0 – 2

Parameter Value	Configuration
0	disabled
1	Enable Binary Programming
2	Enable $\overline{\text{RTS}}$ Flow Control

Default Parameter Value: 0
 Number of bytes returned: 1

SB (Stop Bits) Command

SB Command is used to set/read the number of stop bits in the data packets.

AT Command: ATSB
 Binary Command: 0x36 (54 decimal)
 Parameter Range: 0 – 1

Parameter Value	Configuration
0	1 stop bits
1	2 stop bits

Default Parameter Value: 0
 Number of bytes returned: 1
 Minimum Firmware Version Required: 4.2B

SH (Serial Number High) Command

<Diagnostics> Set/Read the serial number high word of the module.

AT Command: ATSH
 Binary Command: 0x25 (37 decimal)
 Parameter Range: 0 – 0xFFFF [read-only]
 Number of bytes returned: 2
 Related Commands: SL (Serial Number Low)
 Minimum Firmware Version Required: 4.27C

SL (Serial Number Low) Command

<Diagnostics> Set/Read the serial number low word of the module.

AT Command: ATSL
 Binary Command: 0x26 (38 decimal)
 Parameter Range: 0 – 0xFFFF [read-only]
 Number of bytes returned: 2
 Related Commands: SH (Serial Number High)
 Minimum Firmware Version Required: 4.27C

SM (Sleep Mode) Command

<Sleep Mode (Low Power)> SM Command is used to adjust Sleep Mode settings. By default, Sleep Mode is disabled and the module remains continually active. SM Command allows the module to run in a lower-power state and be configured in one of eight settings.

Cyclic Sleep settings wake the module after the amount of time designated by SM Command. If the module detects a wake-up initializer during the time it is awake, it will synchronize with the transmitter and start receiving data after the wake-up initializer runs its duration. Otherwise, it returns to Sleep Mode and continue to cycle in and out of inactivity until the Wake-up Initializer is detected. If a Cyclic Sleep setting is chosen, the ST, LH and HT parameters must also be set as described in the "Sleep Mode" section of this manual.

Pin Sleep (SM = 1)

Pin Sleep requires the least amount of power. In order to achieve this state, SLEEP pin must be asserted (high). The module remains in Pin Sleep until the SLEEP pin is de-asserted.

After enabling Pin Sleep, the SLEEP pin controls whether the XStream Module is active or in Sleep Mode. When SLEEP is de-asserted (low), the module is fully operational. When SLEEP is asserted (high), the module transitions to Sleep Mode and remains in its lowest power-consuming state until the SLEEP pin is de-asserted. SLEEP is only active if the module is setup to operate in this mode; otherwise the pin is ignored.

Once in Pin Sleep Mode, \overline{CTS} is de-asserted (high), indicating that data should not be sent to the module. The PWR pin is also de-asserted (low) when the module is in Pin Sleep Mode.

Note: The module will complete a transmission or reception before activating Pin Sleep.

Serial Port Sleep (SM = 2)

Serial Port Sleep is a Sleep Mode in which the XStream Module runs in a low power state until serial data is detected on the DI pin.

When Serial Port Sleep is enabled, the module goes into Sleep Mode after a user-defined period of inactivity (no transmitting or receiving of data). This period of time is determined by ST (Time before Sleep) Command. Once a character is received through the DI pin, the module returns to Idle Mode and is fully operational.

Cyclic Sleep (SM = 3-8)

Cyclic Sleep is the Sleep Mode in which the XStream Module enters into a low-power state and awakens periodically to determine if any transmissions are being sent.

When Cyclic Sleep settings are enabled, the XStream Module goes into Sleep Mode after a user-defined period of inactivity (no transmission or reception on the RF channel). The user-defined period is determined by ST (Time before Sleep) Command.

While the module is in Cyclic Sleep Mode, \overline{CTS} is de-asserted (high) to indicate that data should not be sent to the module during this time. When the module awakens to listen for data, \overline{CTS} is asserted and any data received on the DI Pin is transmitted. The PWR pin is also de-asserted (low) when the module is in Cyclic Sleep Mode.

AT Command: ATSM

Binary Command: 0x01

Parameter Range: 0 – 8

Parameter Value	Configuration
0	Disabled
1	Pin Sleep
2	Serial Port Sleep
3	Cyclic 0.5 second sleep (Module wakes every 0.5 seconds)
4	Cyclic 1.0 second sleep
5	Cyclic 2.0 second sleep
6	Cyclic 4.0 second sleep
7	Cyclic 8.0 second sleep
8	Cyclic 16.0 second sleep

Default Parameter Value: 0

Number of bytes returned: 1

Related Commands:

For Pin Sleep – PC (Power-up Mode), PW (Pin Wake-up)

For Serial Port Sleep – ST (Time before Sleep)

For Cyclic Sleep – ST (Time before Sleep), LH (Wake-up Initializer Timer), HT (Time Before Wake-up Initializer), PW (Pin Wake-up)

SM Command (continued)

The module remains in Sleep Mode for a user-defined period of time ranging from 0.5 seconds to 16 seconds (SM Parameters 3 through 8). After this interval of time, the module returns to Idle Mode and listens for a valid data packet for 100 ms. If the module does not detect valid data (on any frequency), the module returns to Sleep Mode. If valid data is detected, the module transitions into Receive Mode and receives incoming RF packets. The module then returns to Sleep Mode after a Period of inactivity that is determined by ST “Time before Sleep” Command.

The module can also be configured to wake from cyclic sleep when SLEEP (pin 2) is de-asserted (low). To configure a module to operate in this manner, PW (Pin Wake-up) Command must be issued. Once SLEEP is de-asserted, the module is forced into Idle Mode and can begin transmitting or receiving data. It remains active until no data is detected for the period of time specified by the ST Command, at which point it resumes its low-power cyclic state.

Note: The cyclic interval time defined by SM (Sleep Mode) Command must be shorter than the interval time defined by LH (Wake-up Initializer Timer).

For example: If SM=4 (Cyclic 1.0 second sleep), the LH Parameter should equal 0x0B (“1.1” seconds). With these parameters set, there is no risk of the receiving module being asleep for the duration of wake-up initializer transmission. “Cyclic Scanning” explains in further detail the relationship between “Cyclic Sleep” and “Wake-up Initializer Timer”

Cyclic Scanning. Each RF transmission consists of an RF Initializer and payload. The wake-up initializer contains initialization information and all receiving modules must wake during the wake-up initializer portion of data transmission in order to be synchronized with the transmitting module and receive the data.

Figure 3.1 Correct Configuration (LH > SM)

Length of the wake-up initializer exceeds the time interval of Cyclic Sleep. The receiver is guaranteed to detect the wake-up initializer and receive the accompanying payload data.

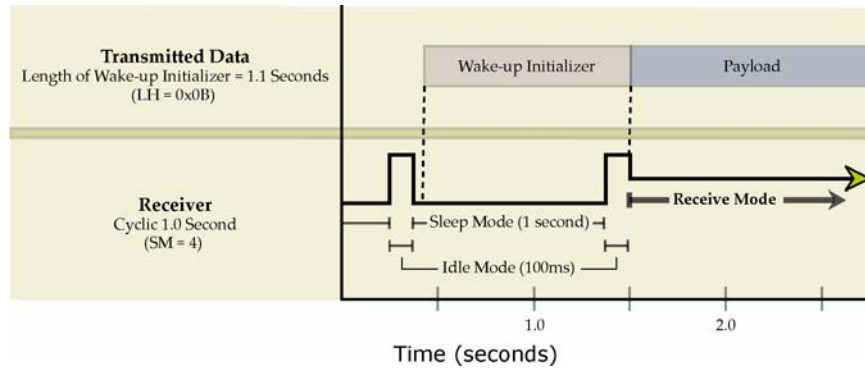
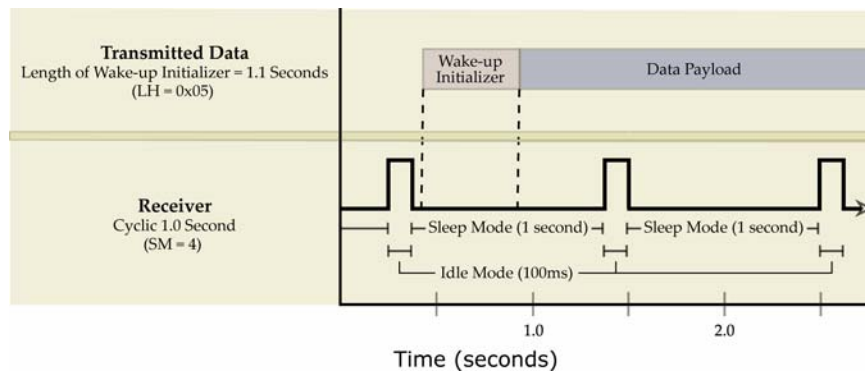

Figure 3.2 Incorrect Configuration (LH < SM)

Length of wake-up initializer is shorter than the time interval of Cyclic Sleep. This configuration is vulnerable to the receiver waking and missing the wake-up initializer (and therefore also the accompanying payload data).



ST (Time before Sleep) Command

<Sleep Mode (Low Power)> ST Command sets the period of time (in tenths of seconds) in which the module remains inactive before entering into Sleep Mode. For example, if the ST Parameter is set to 0x64 (100 decimal), the module will enter into Sleep mode after 10 seconds of inactivity (no transmitting or receiving). This command can only be used if Cyclic Sleep or Serial Port Sleep Mode settings have been selected using SM (Sleep Mode) Command.

AT Command: ATST
 Binary Command: 0x02
 Parameter Range: 0x10 – 0xFFFF
 [x 100 milliseconds]
 Default Parameter Value: 0x64 (100 decimal)
 Number of bytes returned: 2
 Related Commands: SM (Sleep Mode), LH (Wake-up Initializer Timer), HT (Time before Wake-up Initializer)

SY (Time before Initialization) Command

<Networking> SY Command keeps a communication channel open as long as module transmits or receives before the active connection expires. It can be used to reduce latency in a query/response sequence and should be set 100 ms longer than the delay between transmissions.

This command allows multiple XStream Modules to share a hopping channel for a given amount of time after receiving data. By default, all packets include an RF initializer that contains channel information used to synchronize any listening receivers to the transmitter’s hopping pattern. Once a new module comes within range, it is able to instantly synchronize to the transmitter and start receiving data. If no new modules are introduced into the system, the synchronization information becomes redundant once modules have become synchronized.

SY Command allows the modules to remove this information from the RF Initializer after the initial synchronization. For example, changing the SY Parameter to 0x14 (20 decimal) allows all modules to remain in sync for 2 seconds after the last data packet was received. Synchronization information is not re-sent unless transmission stops for more than 2 seconds. This command allows significant savings in packet transmission time.

Warning: Not recommended for use in an interference-prone environment. Interference can break up the session and the communications channel will not be available again until SY time expires.

With SY set to zero, the channel session is opened and closed with each transmission - resulting in a more robust link with more latency.

TR (Transmit Error Count) Command

<Diagnostics> TR Command records the number of retransmit failures. This number is incremented each time a packet is not acknowledged within the number of retransmits specified by the RR (Retries) Command. It therefore counts the number of packets that were not successfully received and have been dropped. The TR Parameter is not non-volatile and will therefore be reset to zero each time the module is reset.

AT Command: ATTR
 Binary Command: 0x1B (27 decimal)
 Parameter Range: 0 – 0xFFFF
 Default Parameter Value: 0
 Number of bytes returned: 2
 Related Commands: RR (Retries)
 Minimum Firmware Version Required: 4.22

TT (Streaming Limit) Command

<Networking> TT Command defines a limit on the number of bytes that can be sent out before a random delay is issued. TT Command is used to simulate full-duplex behavior.

If a module is sending a continuous stream of RF data, a delay is inserted which stops its transmission and allows other modules time to transmit (once it sends number of bytes specified by TT Command). Inserted random delay lasts between 1 & 'RN + 1' delay slots, where each delay slot lasts 38 ms.

AT Command: ATTT

Binary Command: 0x1A (26 decimal)

Parameter Range: 0 - 0xFFFF (0 = disabled)

Default Parameter Value: 0xFFFF (65535 decimal)

Number of bytes returned: 2

Related Commands: RN (Delay Slots)

Minimum Firmware Version Required: 4.22

VR (Firmware Version) Command

<Diagnostics> Read the Firmware Version of the XStream Module.

AT Command: ATVR

Binary Command: 0x14 (20 decimal)

Parameter Range: 0 - 0xFFFF [read-only]

Number of bytes returned: 2

WR (Write) Command

<(Special)> WR Command writes configurable parameters to the module's non-volatile memory (Parameter values remain in the module's memory until overwritten by future use of WR Command).

If changes are made without writing them to non-volatile memory, the module reverts back to previously saved parameters the next time the module is powered-on.

AT Command: ATWR

Binary Command: 0x08

Appendix A: Agency Certifications

FCC Certification

The XStream OEM RF Module complies with Part 15 of the FCC rules and regulations. Compliance with the labeling requirements, FCC notices and antenna usage guidelines is required.

To fulfill the FCC Certification requirements, the OEM must comply with the following FCC regulations:

1. The system integrator must ensure that the text on the external label provided with this device is placed on the outside of the final product [Figure A.1 for 900 MHz operations or Figure A.2 for 2.4 GHz operations].
2. The XStream OEM RF Module may be used only with Approved Antennas that have been tested with this module. [Table A.1 or Table A.2]

FCC Notices:

IMPORTANT: The 9XStream (900 MHz) and 24XStream (2.4 GHz) OEM Modules have been certified by the FCC for use with other products without any further certification (as per FCC section 2.1091). Changes or modifications not expressly approved by MaxStream could void the user's authority to operate the equipment.

IMPORTANT: OEMs must test their final product to comply with unintentional radiators (FCC section 15.107 and 15.109) before declaring compliance of their final product to Part 15 of the FCC Rules.

IMPORTANT: The XStream OEM RF Modules have been certified for remote and base radio applications. If the XStream will be used for portable applications, the device must undergo SAR testing.

This equipment has been tested and found to comply with the limits for a Class B digital device, pursuant to Part 15 of the FCC Rules. These limits are designed to provide reasonable protection against harmful interference in a residential installation. This equipment generates, uses and can radiate radio frequency energy and, if not installed and used in accordance with the instructions, may cause harmful interference to radio communications. However, there is no guarantee that interference will not occur in a particular installation. If this equipment does cause harmful interference to radio or television reception, which can be determined by turning the equipment off and on, the user is encouraged to try to correct the interference by one or more of the following measures:

- Re-orient or relocate the receiving antenna.
- Increase the separation between the equipment and receiver.
- Connect the equipment into an outlet on a circuit different from that to which the receiver is connected.
- Consult the dealer or an experienced radio/TV technician for help.

OEM Labeling Requirements

Label Warning

 **WARNING** The Original Equipment Manufacturer (OEM) must ensure that FCC labeling requirements are met. This includes a clearly visible label on the outside of the final product enclosure that displays the contents shown in the figure below.

Figure A.1. Required FCC Label for OEM products containing 9XStream (900 MHz) OEM RF Module

Contains FCC ID: OUR9XSTREAM
The enclosed device complies with Part 15 of the FCC Rules. Operation is subject to the following two conditions: (1) this device may not cause harmful interference and (2) this device must accept any interference received, including interference that may cause undesired operation.

Figure A.2. Required FCC Label for OEM products containing 24XStream (2.4 GHz) OEM RF Module

Contains FCC ID: OUR-24XSTREAM
The enclosed device complies with Part 15 of the FCC Rules. Operation is subject to the following two conditions: (1) this device may not cause harmful interference and (2) this device must accept any interference received, including interference that may cause undesired operation.

Antenna Usage

Antenna Warning

 **WARNING:** This device has been tested with Reverse Polarity SMA connectors with the antennas listed in Tables A.1 & A.2 of Appendix A. When integrated in OEM products, fixed antennas require installation preventing end-users from replacing them with non-approved antennas. Antennas not listed in the tables must be tested to comply with FCC Section 15.203 (unique antenna connectors) and Section 15.247 (emissions).

RF Exposure

 **WARNING:** This equipment is approved only for mobile and base station transmitting devices, separation distances of (i) 20 centimeters or more for antennas with gains < 6 dBi or (ii) 2 meters or more for antennas with gains \geq 6 dBi should be maintained between the antenna of this device and nearby persons during operation. To ensure compliance, operation at distances closer than this is not recommended.

The preceding statement must be included as a CAUTION statement in manuals for OEM products to alert users on FCC RF Exposure compliance.

MaxStream Modules are pre-FCC approved for use in fixed base station and mobile applications. As long as the antenna is mounted at least 20 cm (8 in) from nearby persons, the application is considered a mobile application. If the antenna will be mounted closer than 20 cm to nearby persons, then the application is considered "portable" and requires an additional test performed on the final product. This test is called the Specific Absorption Rate (SAR) testing and measures the emissions from the module and how they affect the person.

Over 100 additional antennas have been tested and are approved for use with MaxStream 900 MHz Modules (including "Mag Mount", "Dome", "Multi-path" and "Panel" antennas). Because of the large number of approved antennas, MaxStream requests that you send specific information about an antenna you would like to use with the module and MaxStream will evaluate whether the antenna is covered under our FCC filing. Contact MaxStream.

FCC-Approved Antennas

Table A.1. Antennas approved for use with 9XStream (900 MHz) OEM RF Modules.

Manufacturer	Part Number	Type	Gain	Application	Min. Separation Distance
*	*	Yagi	6.2 dBi	Fixed/Mobile **	20 cm
*	*	Yagi	7.2 dBi	Fixed/Mobile **	20 cm
MaxStream	A09-Y8	Yagi	8.2 dBi	Fixed/Mobile **	20 cm
*	*	Yagi	9.2 dBi	Fixed/Mobile **	20 cm
*	*	Yagi	10.2 dBi	Fixed/Mobile **	20 cm
MaxStream	A09-Y11 (FCC pending)	Yagi	11.2 dBi	Fixed/Mobile **	20 cm
MaxStream	A09-F2	Omni Direct.	2.2 dBi	Fixed **	20 cm
MaxStream	A09-F5	Omni Direct.	5.2 dBi	Fixed **	20 cm
MaxStream	A09-F8	Omni Direct.	8.2 dBi	Fixed **	20 cm
*	*	Omni Direct.	9.2 dBi	Fixed **	20 cm
*	*	Omni Direct.	7.2 dBi	Fixed **	20 cm
MaxStream	A09-M7	Omni Direct.	7.2 dBi	Fixed **	20 cm
MaxStream	A09-H	1/2 wave antenna	2.1 dBi	Fixed/Mobile **	20 cm
MaxStream	A09-HBMM-P5I	1/2 wave antenna	2.1 dBi	Fixed/Mobile **	1 cm
MaxStream	A09-QBMM-P5I	1/4 wave antenna	1.9 dBi	Fixed/Mobile **	1 cm
*	*	1/4 wave integrated wire antenna	1.9 dBi	Fixed/Mobile **	1 cm

Table A.2. Antennas approved for use with 24XStream (2.4 GHz) OEM RF Modules.

Manufacturer	Part Number	Type	Gain	Application	Min. Separation Distance
*	*	Yagi	6 dBi	Fixed **	2 m
*	*	Yagi	8.8 dBi	Fixed **	2 m
*	*	Yagi	9 dBi	Fixed **	2 m
*	*	Yagi	10 dBi	Fixed **	2 m
*	*	Yagi	11 dBi	Fixed **	2 m
*	*	Yagi	12 dBi	Fixed **	2 m
*	*	Yagi	12.5 dBi	Fixed **	2 m
*	*	Yagi	13.5 dBi	Fixed **	2 m
*	*	Yagi	15 dBi	Fixed **	2 m
*	*	Omni Direct	2.1 dBi	Fixed/Mobile **	20 cm
*	*	Omni Direct	3 dBi	Fixed/Mobile **	20 cm
*	*	Omni Direct	5 dBi	Fixed/Mobile **	20 cm
*	*	Omni Direct	7.2 dBi	Fixed **	2 m
*	*	Omni Direct	8 dBi	Fixed **	2 m
*	*	Omni Direct	9.5 dBi	Fixed **	2 m
*	*	Omni Direct	10 dBi	Fixed **	2 m
*	*	Omni Direct	12 dBi	Fixed **	2 m
*	*	Omni Direct	15 dBi	Fixed **	2 m
MaxStream	A24-P8	Panel	8.5 dBi	Fixed **	2 m
MaxStream	A24-P13	Panel	13 dBi	Fixed **	2 m
*	*	Panel	14 dBi	Fixed **	2 m
*	*	Panel	15 dBi	Fixed **	2 m
*	*	Panel	16 dBi	Fixed **	2 m
MaxStream	A24-P19	Panel	19 dBi	Fixed **	2 m
MaxStream	A24-HABMM-P6I	Dipole	2.1 dBi	Fixed/Mobile **	20 cm
MaxStream	A24-HBMM-P6I	Dipole	2.1 dBi	Fixed/Mobile **	20 cm
MaxStream	A24-HABSM	Dipole	2.1 dBi	Fixed/Mobile **	20 cm
MaxStream	A24-QABMM-P6I	Monopole	1.9 dBi	Fixed/Mobile **	20 cm
MaxStream	A24-Q1	Monopole	1.9 dBi	Fixed/Mobile **	20 cm
*	*	Monopole	1.9 dBi	Fixed/Mobile **	20cm

* FCC-approved antennas not inventoried by MaxStream – Contact MaxStream (866) 765-9885 for information.

** Can be approved for portable applications if integrator gains approval through SAR testing

European Compliance (2.4 GHz only)

The 24XStream has been certified for use in several European countries. For a complete list, refer to <http://www.maxstream.net>.

If the 24XStream Modules are incorporated into a product, the manufacturer must ensure compliance of the final product to the European harmonized EMC and low-voltage/safety standards. A Declaration of Conformity must be issued for each of these standards and kept on file as described in Annex II of the R&TTE Directive. Furthermore, the manufacturer must maintain a copy of the XStream user manual documentation and ensure the final product does not exceed the specified power ratings, antenna specifications, and/or installation requirements as specified in the user manual. If any of these specifications are exceeded in the final product, a submission must be made to a notified body for compliance testing to all required standards.

OEM Labeling Requirements

The 'CE' marking must be affixed to a visible location on the OEM product.

Figure A.3. CE Labeling Requirements

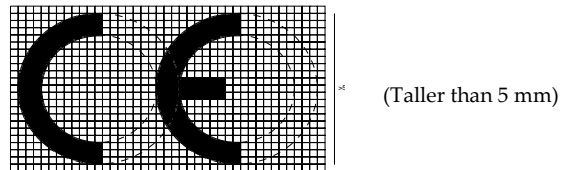

The CE mark shall consist of the initials "CE" taking the following form:

- If the CE marking is reduced or enlarged, the proportions given in the above graduated drawing must be respected.
- The CE marking must have a height of at least 5mm except where this is not possible on account of the nature of the apparatus.
- The CE marking must be affixed visibly, legibly, and indelibly.

Furthermore, since the usage of the 2400 – 2483.5 MHz band is not harmonized throughout Europe, the Restriction sign must be placed to the right of the 'CE' marking as shown below. See the R&TTE Directive, Article 12 and Annex VII for more information

Figure A.4. CE Label Required on OEM Equipment



Restrictions

France – France imposes restrictions on the 2.4 GHz band. Go to www.art-telecom.fr or contact MaxStream for more information.

Norway – Norway prohibits operation near Ny-Alesund in Svalbard. More information can be found at the Norway Posts and Telecommunications site (www.npt.no).

24XStream Declarations of Conformity

MaxStream has issued Declarations of Conformity for the 24XStream Modules concerning emissions, EMC and safety. Files are located in the 'documentation' folder of the MaxStream CD.

Important Note

MaxStream does not list the entire set of standards that must be met for each country. MaxStream customers assume full responsibility for learning and meeting the required guidelines for each country in their distribution market. For more information relating to European compliance of an OEM product incorporating the 24XStream Module, contact MaxStream, or refer to the following web sites:

CEPT ERC 70-03E – Technical Requirements, European restrictions and general requirements: Available at www.ero.dk/

R&TTE Directive – Equipment requirements, placement on market: Available at www.ero.dk/

Notifications and Required Information

Since the 2.4 GHz band is not harmonized throughout Europe, a notification must be sent to each country prior to shipping product according to Article 6.4 of the R&TTE Directive. A list of national contacts for most European countries may be found at www.ero.dk/.

The following technical data (relating to the 24XStream) is often required in filling out a notification form.

- Frequency Band: 2400.0 – 2483.5 MHz
- Modulation: Frequency Shift Keying
- Channel Spacing: 400 kHz
- ITU Classification: 400KF1D
- Output Power: 100 mW EIRP
- Notified Body Number: 0891

Contact MaxStream (801) 765-9885 if additional information is required.

Europe (2.4 GHz) Approved Antenna List

Table A.3. Antennas approved for use with 24XStream (2.4 GHz) RF Modules in Europe

Manufacturer	Part Number	Type	Gain	Application	Min. Separation Distance
MaxStream	A24-HABMM-P6I	Dipole	2.1 dBi	Fixed/Mobile *	20cm
MaxStream	A24-HBMM-P6I	Dipole	2.1 dBi	Fixed/Mobile *	20cm
MaxStream	A24-HABSM	Dipole	2.1 dBi	Fixed/Mobile *	20cm
MaxStream	A24-QABMM-P6I	Monopole	1.9 dBi	Fixed/Mobile *	20cm
MaxStream	A24-QBMM-P6I	Monopole	1.9 dBi	Fixed/Mobile *	20cm
MaxStream	A24-Q1	Monopole	1.9 dBi	Fixed/Mobile *	20cm

* Can be approved for portable applications if integrator gains approval through SAR testing

IC (Industry Canada) Certification

Labeling requirements for Industry Canada are similar to those of the FCC. A clearly visible label on the outside of the final product enclosure must display the following text:

Contains Model 9XStream Radio (900 MHz), IC: 4214A-9XSTREAM

Contains Model 24XStream Radio (2.4 GHz), IC: 4214A 12008

Integrator is responsible for its product to comply with IC ICES-003 & FCC Part 15, Sub. B - Unintentional Radiators. ICES-003 is the same as FCC Part 15 Sub. B and Industry Canada accepts FCC test report or CISPR 22 test report for compliance with ICES-003.

Appendix B: Development Guide

XStream OEM Development Kit Contents

The Development Kit includes all the hardware and software needed for a robust wireless link:

Table B.1. XStream Development Kit Contents

Item	Qty.	Description	Part Number
Quick Start Guide	1	Familiarizes users with some of the module's most important functions.	MD0016
CD	1	Contains documentation, software and tools needed for RF operation.	MD0018
XStream OEM RF Module	1	Long Range OEM RF Module w/ RPSMA Connector	varies
XStream OEM RF Module	1	Long Range OEM RF Module w/ attached wire antenna	varies
MaxStream Interface Board	2	Enables communication to RS-232/485/422 devices	XIB-R
Antenna	1	900 MHz RPSMA, 6" Half-Wave, dipole, articulating	A09-HASM-675
Serial Loopback Adapter	1	Connects to the female RS-232 (DB-9) serial connector of the MaxStream Interface Board and can be used to configure the module to function as a repeater (for range testing)	JD2D3-CDL-A
NULL Modem Adapter (male-to-male)	1	Connects to the female RS-232 (DB-9) serial connector of the MaxStream Interface Board and can be used to connect the module to another DCE (female DB9) device	JD2D2-CDN-A
NULL Modem Adapter (female-to-female)	1	Used to bypass radios to verify serial cabling is functioning properly	JD3D3-CDN-A
Male DB-9 to RJ-45 Adapter	1	Facilitates adapting the DB-9 Connector of the MaxStream Interface Board to a CAT5 cable (male DB9 to female RJ45)	JE1D2-CDA-A
Female DB-9 to RJ-45 Adapter	1	Facilitates adapting the DB-9 Connector of the MaxStream Interface Board to a CAT5 cable (female DB9 to female RJ45)	JE1D3-CDA-A
Power Adapter	2	Allows Interface Board to be powered by a 110 Volt AC power supply	JP4P2-9V10-6F
RS-232 Cable (6')	2	Connects interface board to devices having an RS-232 serial port	JD2D3-CDS-6F

Interfacing Hardware

MaxStream developed proprietary interface boards to facilitate the connection between XStream OEM RF Modules and serial devices. MaxStream has developed an interface board that supports the RS-232/485/422 protocols (MaxStream part number: XIB-R).

The following section illustrates properties of the MaxStream XIB-R Interface Board. The MaxStream Interface board provides means for connecting the XStream Module to any node that has an available RS-232 or RS-485/422 connection. Since the module requires signals to enter at CMOS voltages, one of the main functions of the interface board is to convert signals between CMOS and RS-232 levels.

MaxStream RS-232/485 Interface Board

Figure B.1. Front View

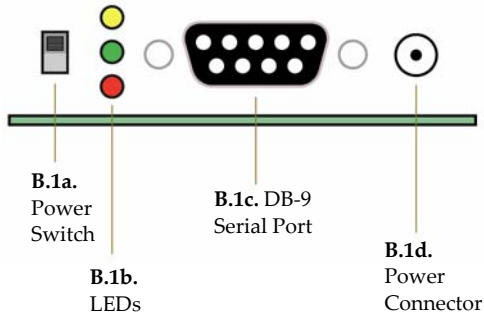

B.1.a. Power Switch

Move the Power Switch to the on (up) position to power the Interface Board. DIP Switch [B.2a] settings are only read during a power-up sequence.

B.1.b. LEDs

The LED indicators visualize diagnostic status information. The module's status is represented as follows:

- Yellow (top LED) = Serial Data Out (to host)
- Green (middle) = Serial Data In (from host)
- Red (bottom) = Power/TX Indicator (Red light is on when powered, off briefly during RF transmission)



B.1.c. DB-9 Serial Port

Standard female DB-9 (RS-232) DCE connector – This connector can be also used for RS-485 and RS-422 connections.

B.1.d. Power Connector

7-18 VDC Power Connector (Center positive, 5.5/2.1mm) – Power can also be supplied through Pin 9 of the DB-9 Serial Port.

Figure B.2. Back View

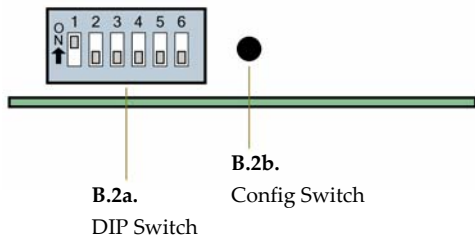

B.2.a. DIP Switch

The DIP Switch automatically configures the XStream OEM RF Module to operate in different modes. Each time the module assembly (interface board + the RF Module) is powered-on, intelligence on the XIB-R interface board programs the module according to the positions of the DIP Switch. [See figure below for DIP Switch settings]

NOTE: In cases where AT Commands should not be sent each time the module assembly is powered-on, the processor must be disabled by populating J7 on the interface board.

B.2.b. Config (Configuration) Switch

The Configuration Switch provides an alternate way to enter "AT Command Mode". To enter "AT Command Mode" at the module's default baud rate, hold the Configuration Switch down while powering on the module using the Power Switch [B.1a].

Figure B.3. MaxStream XIB-R (RS-232/485) Interface Board DIP Switch Settings

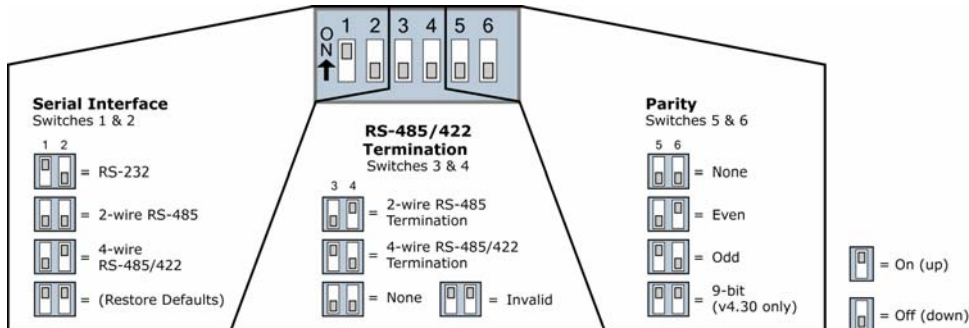

Refer to table in the Automatic DIP Switch Configurations section [next page] for more information regarding configurations triggered by the DIP Switch.

Automatic DIP Switch Configurations

Each time the module assembly (XStream Module mounted to an XIB-R Interface Board) is powered on, intelligence on the MaxStream Interface Board sends AT Commands that program the module based on positions of the DIP Switch. Automatic configurations that take place during the power-on sequence affect module parameter values as shown below.

To avoid overwriting previously stored custom configurations (due to the automatic configurations that take place each time the module assembly is powered on), it is necessary to disable a processor located on the XIB-R interface board. To disable the processor, populate J7 of the XIB-R Interface Board. By default, J7 jumper is not populated.

Table B.2. Module Power-up Options (J7 jumper and Config Switch)

Condition	Behavior
If J7 is populated	Processor is disabled and AT Commands are not sent to the Module.
If Config Switch is pressed	Processor is disabled and Module enters into AT Command Mode.
If J7 is NOT populated and Config Switch is NOT pressed	Execute logic as shown in table below.

Table B.3. AT Commands Sent as result of DIP Switch Settings (SW = DIP Switch)

Condition	Behavior
Restore Default Parameter Values of the Module	
If SW1 & SW2 are ON (up)	AT Commands sent: ATRE (Restore Defaults) Command ATWR (Write) Command
Serial Interfacing Options	
If SW1 is ON (up)	AT Commands sent: ATCS 0 (RS-232 Operation: CTS function for CTS line, DB-9 pin 8) ATCD 2 (DO3 - RX LED = low)
If SW1 is OFF (down)	AT Commands sent: ATCS 3 (RS-485 or RS-422 Operation) ATCD 2 (DO3 - RX LED = low)
Parity Options	
If SW5 & SW6 are OFF (down)	AT Commands sent: ATNB 0 (parity = none)
If SW5 is OFF (down) & SW6 is ON (up)	AT Commands sent: ATNB 1 (parity = even)
If SW5 is ON (up) & SW6 is OFF (down)	AT Commands sent: ATNB 2 (parity = odd)
If SW5 is ON (up) & SW6 is ON (up)	AT Commands sent: ATNB 5 (parity = 9th bit data over-the-air)
Exit AT Command Mode	
Always	AT Commands sent: ATCN (Exit AT Command Mode)

Adapters

The XStream Development Kit comes with several adapters that support the following functions:

- Performing Range Tests
- Testing Cables
- Connecting to other RS-232 DCE and DTE devices
- Connecting to terminal blocks or RJ-45 (for RS-485/422 devices)

NULL Modem Adapter (male-to-male)

Part Number: JD2D2-CDN-A (Black, DB-9 M-M) The male-to-male NULL modem adapter is used to connect two DCE devices. A DCE device connects with a straight-through cable to the male serial port of a computer (DTE).

Figure B.4. Male NULL modem adapter and pinouts

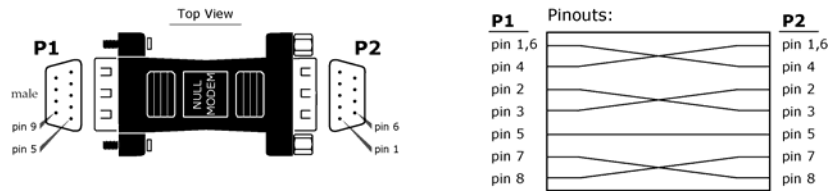
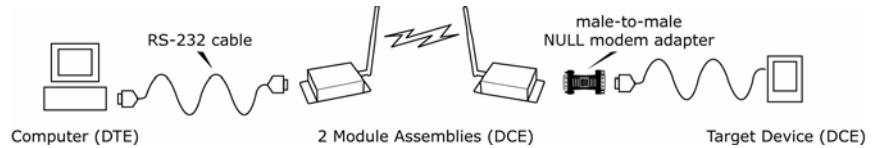

Figure B.5. Example of a module assembly (DCE Device) connecting to another DCE device



NULL Modem Adapter (female-to-female)

Part Number: JD3D3-CDN-A (Gray, DB-9 F-F) The female-to-female NULL modem adapter is used to verify serial cabling is functioning properly. To test cables, insert the female-to-female NULL modem adapter in place of a pair of module assemblies (XIB-R-R interface board + XStream Module) and test the connection without radio modules in the connection.

Figure B.6. Female NULL modem adapter and pinouts

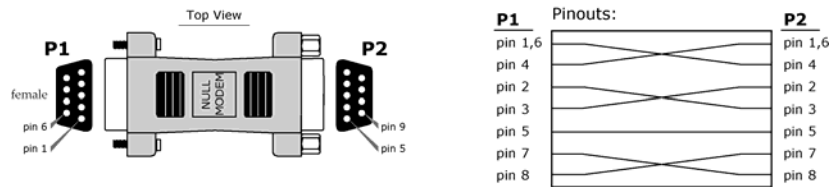

Serial Loopback Adapter

Part Number: JD2D3-CDL-A (Red, DB-9 M-F) The serial loopback adapter is used for range testing. During a range test, the serial loopback adapter configures the module assembly to function as a repeater by looping serial data back into the radio for retransmission.

Figure B.7. Serial loopback adapter and pinouts

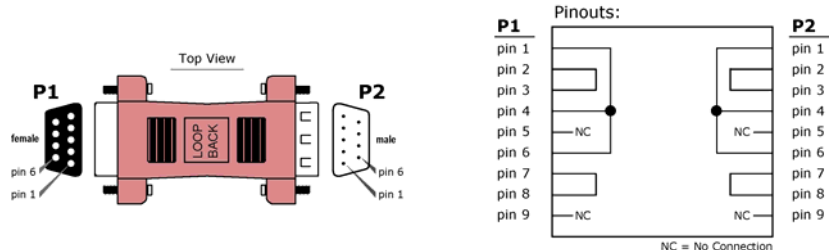

For use in RS-485/422 systems: DB-9 to RJ-45 adapters are documented on p45.

Antennas

[Refer to Appendix A for a list of FCC-Approved Antennas]

Factors that determine wireless link range:

- Ambient RF noise (interference)
- Line-of-sight obstructions
- Transmit power
- Receive sensitivity
- Antenna configuration

XStream Antenna Connector Options

To comply with the FCC rules and obtain a “modular” certification, it is required that XStream Modules utilize a “non standard” connector. This is to ensure the modules are used only with approved antennas. The XStream Modules have two connector options:

- RPSMA
- MMCX

Alternatively, the XStream Module can be order with an attached wire antenna.

RPSMA

The Reverse Polarity SMA (RPSMA) connector uses the same body as a regular SMA connector. In order to be a “non standard” connector, the gender of the center conductor is changed. The female RPSMA actually has a male center conductor.



MMCX

The Micro-Miniature Connector (MMCX) is a good solution for high volume, price-sensitive applications. The small size and snap on connection make it suitable for attaching an external mounted antenna to a module inside an enclosure.



Antenna Cables

RF cables are typically used to connect a radio installed in a cabinet to an antenna mounted externally. As a general rule, it is best to keep the RF cable as short as possible. All cables promote signal loss which is usually measured in dB loss per 100 ft. MaxStream provides LMR-195 rated cables. Common cables and dB losses are included in this table:

Table B.4. Potential Signal Strength Loss due to Antenna Cable Length

Cable Type	Loss at 900 MHz per 100' (loss per 100m)	Loss at 2.4 GHz per 100' (loss per 100m)	Diameter
RG-58	14.5 dB (47.4 dB)	25.3 dB (83.2 dB)	0.20" (4.95 mm)
RG-174	25.9 dB (85.0 dB)	44.4 dB (145.8 dB)	0.10" (2.54 mm)
RG-316	24.7 dB (81.0 dB)	42.4 dB (139.0 dB)	0.10" (2.59 mm)
LMR-195	11.1 dB (36.5 dB)	19.0 dB (62.4 dB)	0.20" (4.95 mm)
LMR-240	7.6 dB (24.8 dB)	12.9 dB (42.4 dB)	0.24" (6.10 mm)
LMR-600	2.5 dB (8.2 dB)	4.4 dB (14.5 dB)	0.59" (15.0 mm)

Interfacing Protocols

The Module Assembly supports the following interfacing protocols:

- RS-232
- RS-485 (2-wire) Half-Duplex
- RS-485 (4-wire) and RS-422

RS-232 Operation

DIP Switch Settings and Serial Port Connections

Figure B.8.
RS-232 DIP Switch Settings



DIP Switch settings are read and applied only while powering-on.

Figure B.9
Pins used on the female RS-232 (DB-9) Serial Connector

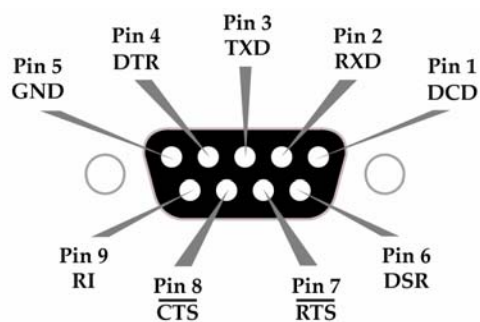

Table B.5. RS-232 Signals and their implementations on the XStream Module Assembly
(Low-asserted signals are distinguished by horizontal line over pin name.)

DB-9 Pin	RS-232 Name	AT Command Reference*	Description	Implementation
1	DCD	DO3	Data-Carrier-Detect	Connected to DSR (pin6)
2	RXD	DO	Received Data	Serial data exiting the Module Assembly (to host)
3	TXD	DI	Transmitted Data	Serial data entering into the Module Assembly (from host)
4	DTR	DI3	Data-Terminal-Ready	Can enable POWER-DOWN on the Module Assembly
5	GND	-	Ground Signal	Ground
6	DSR	DO3	Data-Set-Ready	Connected to DCD (pin1)
7	$\overline{\text{RTS}}$ / CMD	DI2	Request-to-Send	Provides $\overline{\text{RTS}}$ flow control or enables "Command Mode" on the Module
8	$\overline{\text{CTS}}$	DO2	Clear-to-Send	Provides $\overline{\text{CTS}}$ flow control
9	DI	-	Ring Indicator	Optional power input that is connected internally to the positive lead of the front power connector

* The AT Command Reference provides as associative tag when using the AT commands to program the Module. "DI" stands for Data Input and "DO" for Data Output.

Wiring Diagram: RS-232 DTE Device to a DCE Module Assembly

Figure B.10. RS-232 DTE (male connector) device wired to an XStream Module Assembly (female connector)

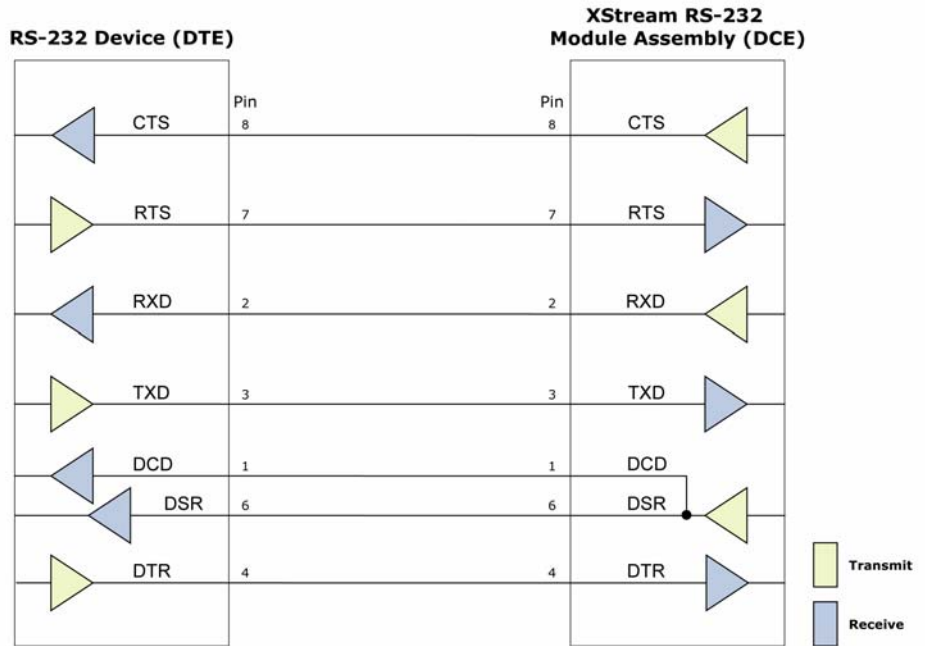

Wiring Diagram: DCE Module Assembly to an RS-232 DCE Device

Figure B.11. XStream Module Assembly (female connector) wired to an RS-232 DTE (male connector) device

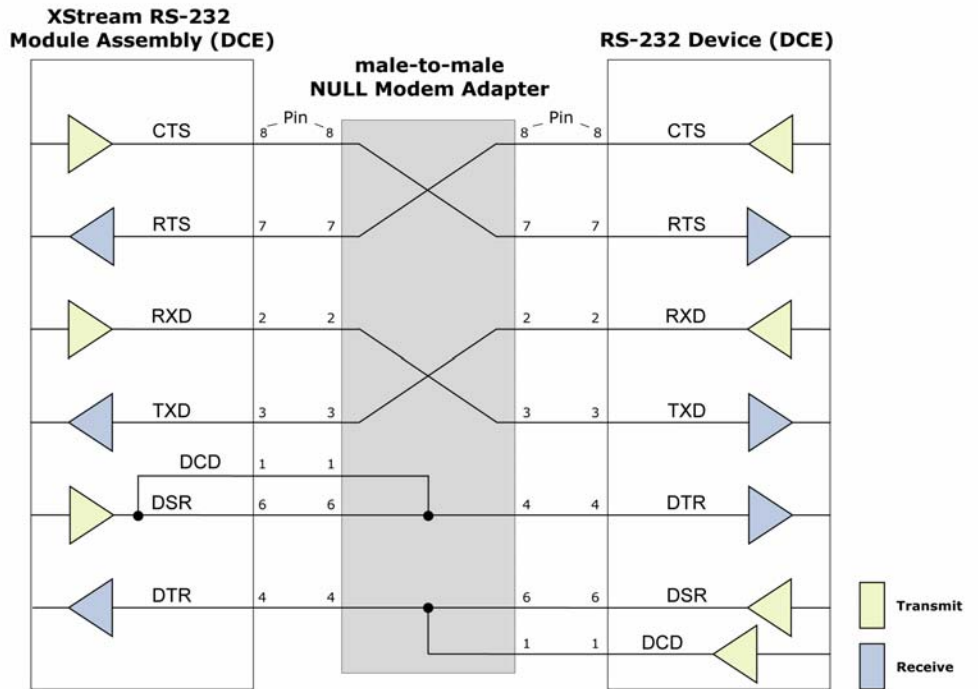

Sample Wireless Connection: DTE ↔ DCE ←-----→ DCE ↔ DCE

Figure B.12 Typical wireless connection used for serial communications between DTE and DCE devices

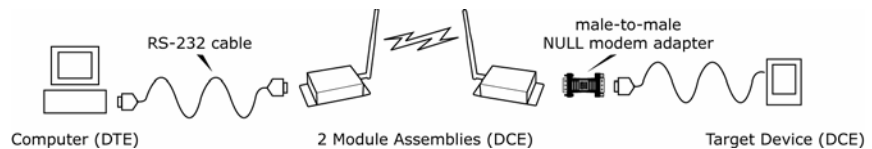

RS-485 (2-wire) Operation

DIP Switch Settings and Serial Port Connections

Figure B.13.
RS-485 (2-wire) Half-Duplex
DIP Switch Settings

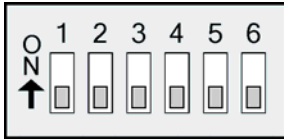

Figure B.15
RS-485 (2-wire) with Termination (optional)



Termination is the 120 Ω resistor between T+ and T-.

DIP Switch settings are read and applied only while powering-on.

Figure B.14.
Pins used on the female RS-232 (DB-9)
Serial Connector

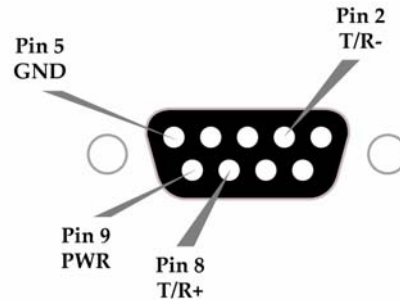

Note: Refer to Figure B.22. & Figure B.23 [p45] for RJ-45 connector pin designations used in RS-485/422 environments.

Table B.6. RS-485 (2-wire half-duplex) Signals and their implementations on the XStream Module Assembly

DB-9 Pin	RS-485 Name	Description	Implementation
2	T/R- (TRA)	Negative Data Line	Transmit serial data to and from the XStream Module Assembly
5	GND	Ground Signal	Ground
8	T/R+ (TRB)	Positive Data Line	Transmit serial data to and from the XStream Module Assembly
9	PWR	Power	Optional power input that is connected internally to the front power connector
1, 3, 4, 6, 7			not used

Wiring Diagram: RS-485 (2-wire) Half-Duplex

Figure B.16. XStream Module Assembly in an RS-485 (2-wire) half-duplex environment

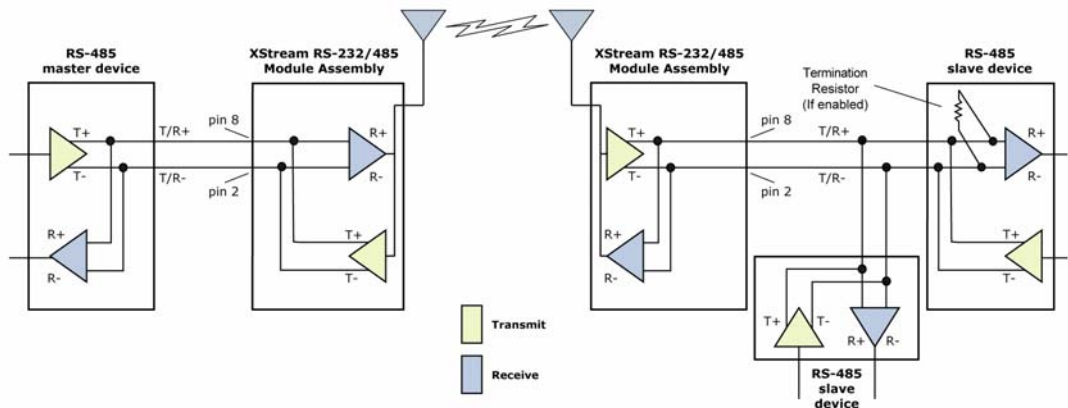

RS-485 (4-wire) & RS-422 Operation

DIP Switch Settings and Serial Port Connections

Figure B.17
RS-485 (4-wire) and RS-422
DIP Switch Settings

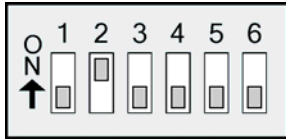
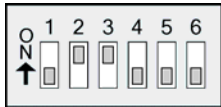

Figure B.19
RS-485 (4-wire) & RS-422 with Termination (optional)



Termination is the 120 Ω resistor between T+ and T-.

DIP Switch settings are read and applied only while powering-on.

Figure B.18
Pins used on the female RS-232 (DB-9)
Serial Connector

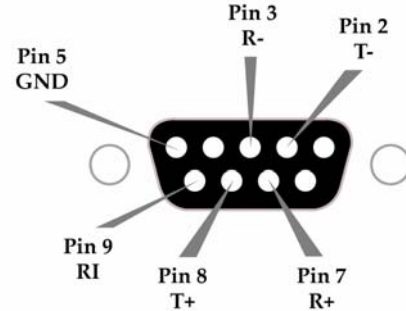
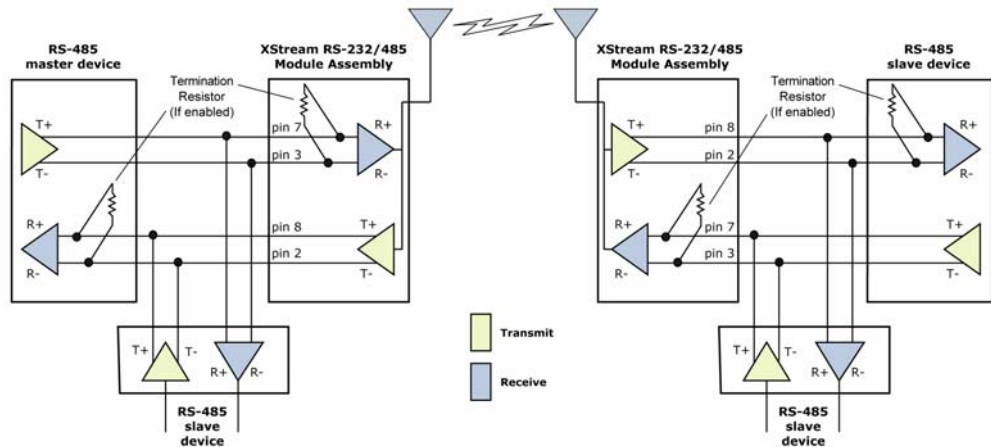

Table B.7. RS-485/422 (4-wire) Signals and their implementations with the Module Assembly

DB-9 Pin	RS-485/422 Name	Description	Implementation
2	T- (TA)	Transmit Negative Data Line	Serial data sent from the XStream Module Assembly
3	R- (RA)	Receive Negative Data Line	Serial data received by the XStream Module Assembly
5	GND	Signal Ground	Ground
7	R+ (RB)	Receive Positive Data Line	Serial data received by the XStream Module Assembly
8	T+ (TB)	Transmit Positive Data Line	Serial data sent from the XStream Module Assembly
9	PWR	Power	Optional power input that is connected internally to the front power connector
1, 4, 6			not used

Wiring Diagram: RS-485 (4-wire) Half-Duplex

Figure B.20. XStream Module Assembly in an RS-485 (4-wire) environment



Wiring Diagram: RS-422

Figure B.21. XStream Module Assembly in an RS-485 (4-wire) environment

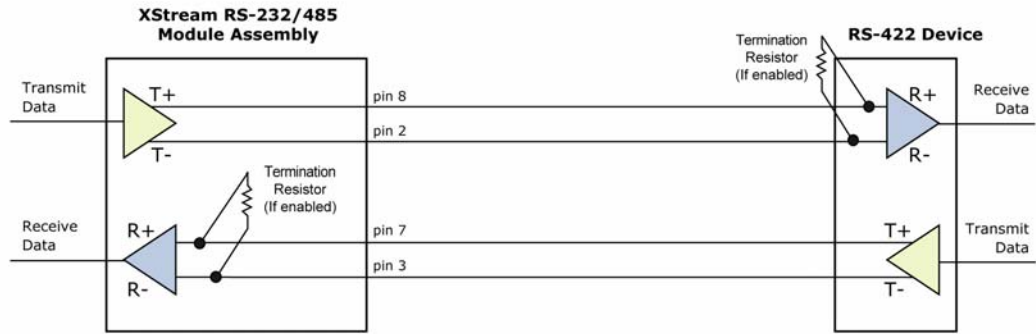

RS-485/422 Connection Guidelines

The RS-485/422 protocol provides a solution for wired communications that can tolerate high noise and push signals over long cable lengths. RS-485/422 signals can communicate as far as 4000 feet (1200 m). RS-232 signals are suitable for cable distances up to 100 feet (30.5 m).

RS-485 offers multi-drop capability in which up to 32 nodes can be connected. The RS-422 protocol is used for point-to-point communications.

Suggestions for integrating the XStream Module with the RS-485/422 protocol:

1. When using Ethernet twisted pair cabling: Select wires so that T+ and T- are connected to each wire in a twisted pair. Likewise, select wires so that R+ and R- are connected to a twisted pair. (For example, tie the green and white/green wires to T+ and T-.)
2. For straight-through Ethernet cable (not cross-over cable) – The following wiring pattern works well: Pin3 to T+, Pin4 to R+, Pin5 to R-, Pin6 to T-
3. Note that the connecting cable only requires 4 wires (even though there are 8 wires).
4. When using phone cabling (RJ-11) – Pin2 in the cable maps to Pin3 on opposite end of cable and Pin1 maps to Pin4 respectively.

Figure B.22 Male (yellow) DB-9 to RJ-45 Adapters

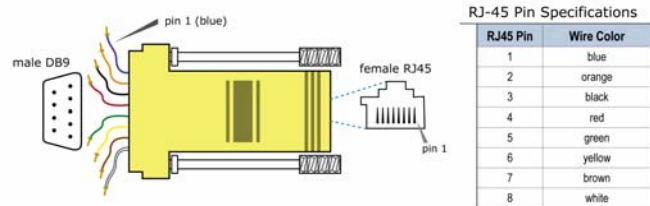
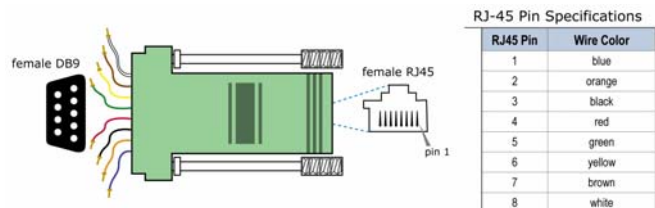

Figure B.23. Female (green) DB-9 to RJ-45 Adapters



X-CTU Software

Using the X-CTU Software

X-CTU is MaxStream-provided software used to interface with and configure XStream OEM RF Modules. The software application is organized into the following four tabs:

- PC Settings tab - Setup PC serial ports to interface with an XStream Module assembly
- Range Test tab – Test XStream Module's range and monitor packets sent and received
- Terminal tab – Set and read XStream Module parameters using AT Commands
- Modem Configuration tab – Set and read XStream Module parameters

Figure B.24 X-CTU User Interface (PC Settings, Range Test, Terminal and Modem Configuration tabs)

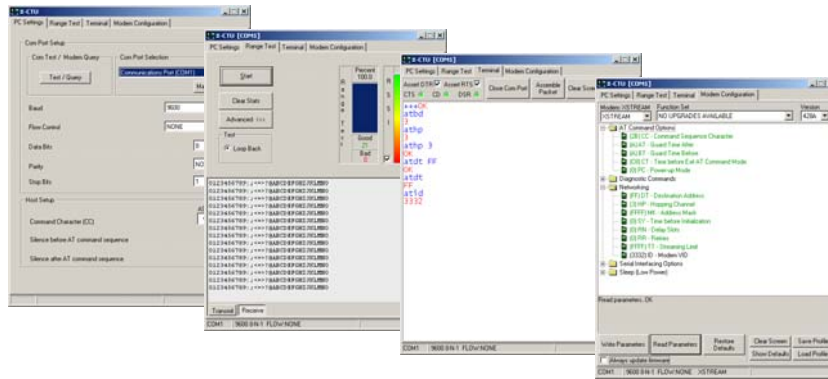

Install X-CTU software

Double-click the "setup_X-CTU.exe" file and follow prompts of the installation screens. This file is located in the 'software' folder of the MaxStream CD and also under the 'Downloads' section of the following web page: <http://www.maxstream.net/helpdesk/download.php>

Setup

To use the X-CTU software, a module assembly (XStream Module mounted to a MaxStream XIB-R-R Interface Board) must be connected to the serial port of a PC. The data rate and parity settings of the serial port ("PC Settings" tab) must match those of the module (BD (Baud Rate) and NB (Parity) Commands).

Serial Communications Software

A terminal program is built into the X-CTU Software. Other terminal programs such as "HyperTerminal" can also be used. When issuing AT Commands through a terminal program interface, use the following syntax:

Figure B.25 Syntax for sending AT Commands:

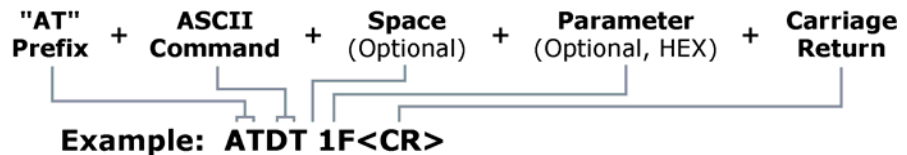

NOTE: To read a parameter value stored in a register, leave the parameter field blank.

The example above issues DT Command to change destination address of the module to "0x1F". To save the new value to the module's non-volatile (long term) memory, issue WR (Write) Command after modifying parameters.

Appendix C: Additional Information

1-Year Warranty

XStream OEM RF Modules from MaxStream, Inc. (the "Product") are warranted against defects in materials and workmanship under normal use, for a period of 1-year from the date of purchase. In the event of a product failure due to materials or workmanship, MaxStream will repair or replace the defective product. For warranty service, return the defective product to MaxStream, shipping prepaid, for prompt repair or replacement.

The foregoing sets forth the full extent of MaxStream's warranties regarding the Product. Repair or replacement at MaxStream's option is the exclusive remedy. THIS WARRANTY IS GIVEN IN LIEU OF ALL OTHER WARRANTIES, EXPRESS OR IMPLIED, AND MAXSTREAM SPECIFICALLY DISCLAIMS ALL WARRANTIES OF MERCHANTABILITY OR FITNESS FOR A PARTICULAR PURPOSE. IN NO EVENT SHALL MAXSTREAM, ITS SUPPLIERS OR LICENSORS BE LIABLE FOR DAMAGES IN EXCESS OF THE PURCHASE PRICE OF THE PRODUCT, FOR ANY LOSS OF USE, LOSS OF TIME, INCONVENIENCE, COMMERCIAL LOSS, LOST PROFITS OR SAVINGS, OR OTHER INCIDENTAL, SPECIAL OR CONSEQUENTIAL DAMAGES ARISING OUT OF THE USE OR INABILITY TO USE THE PRODUCT, TO THE FULL EXTENT SUCH MAY BE DISCLAIMED BY LAW. SOME STATES DO NOT ALLOW THE EXCLUSION OR LIMITATION OF INCIDENTAL OR CONSEQUENTIAL DAMAGES. THEREFOR, THE FOREGOING EXCLUSIONS MAY NOT APPLY IN ALL CASES. This warranty provides specific legal rights. Other rights which vary from state to state may also apply.

Ordering Information

Figure C.1 MaxStream OEM RF Module Part Numbers Key

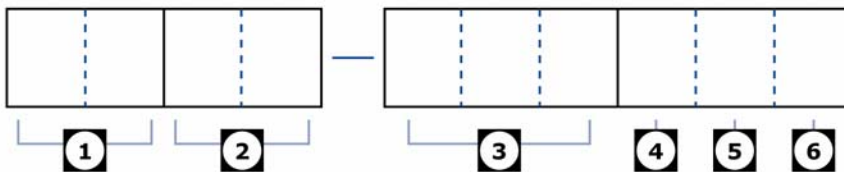

Divisions of the MaxStream OEM RF Module Part Number:

- | | |
|--|---|
| <p>1 MaxStream Product Family
 XC = XCite
 X = XStream
 XT = XTend</p> | <p>4 Wire Antenna
 W = Wire Antenna
 N = No wire antenna</p> |
| <p>2 Operating Frequency
 09 = 902-928 MHz
 24 = 2.4000 - 2.4835 GHz
 (XStream only)
 H9 = 923 MHz (XStream only)</p> | <p>5 Antenna Connector
 S = RPSMA Connector
 M = MMCX
 N = No connector (wire antenna)</p> |
| <p>3 Throughput Data Rate
 001 = 1200 bps (XStream only)
 009 = 9600 bps
 019 = 19200 bps (XStream only)
 038 = 38400 bps (XCite Only)
 (blank) = All XTend RF Modems support 9600 & 115200 bps (software selectable)</p> | <p>6 Temperature Rating
 C = Commercial: 0 to 70° C
 I = Industrial: -40 to 85° C, conformal coated
 T = Tested: -40 to 85° C, conformal coating & 100% tested</p> |

Contact MaxStream

Free and unlimited technical support is included with every MaxStream Radio Modem sold.

Please use the following resources for additional support:

Documentation:		http://www.maxstream.net/helpdesk/download.php
Technical Support:	Phone.	(866) 765-9885 toll-free U.S. & Canada (801) 765-9885 Worldwide
	Live Chat.	www.maxstream.net
	E-Mail.	rf-xperts@maxstream.net

MaxStream office hours are 8:00 am – 5:00 pm [U.S. Mountain Standard Time]